

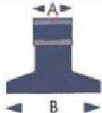





















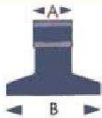

# Catálogo forestal – desbroce













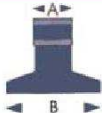

# MARTILLOS

Máquina	Imagen	Modelo	Medidas	Radio	Orificio	Peso
						
HMF Fisher Votex Chabas Rotoram		M1	A=70 B=170	88	16,4 20,5	1,86
HMF Fisher Votex Chabas Rotoram		M2	A=70 B=165	88	16,5	1,46
Picursa Agrimaster Muratori Zappator		M2/A	A=55 B=150	100	20,5	1,80
Agrator Willibald Nobili Lipa Jonvues		M3	A=90 B=160	110	20,5	1,56
Ferria		M4	A=42 B=80	115	25,5	1,17
Mc. Conell		M5	A=40 B=60	134	25,5	0,95
Ferri Rotoram		M6	A=70 B=180	100	16,5	2,28
S.C.A.I. Cabe Milá Cancela		M7	A=70 B=195	85	20,5	2,15









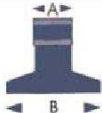

# MARTILLOS

Máquina	Imagen	Modelo	Medidas	Radio	Orificio	Peso
						
Sauerburger		M8	A=60 B=150	85	16,5	0,90
Agrimaster Muratori Zappator Falconer Sicma/Mo		M10	A=55 B=150	100	20,5 16,5	1,62
Aedes S.C.A.I. Rotoram		M11	A=70 B=195	88	16,5	1,70
Willibald		M13	A=40 B=27 Øe=85	174	35,5	3,10
Willibald		M13/A	A=78 B=20	11z5	25,5	1,17
Nicolas		M14	A=42 B=42 Øe=85	125	35,5	3,20
Agrimaster Muratori Zappator Sicma		M20	A=55 B=150	100	16,5 20,5	1,70
Agrimaster Zanon		M37	A=40 B=85	100	20,5 16,5 14,5	0,64







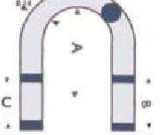
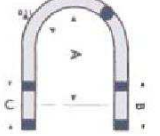





# MARTILLOS

Máquina	Imagen	Modelo	Medidas	Radio	Orificio	Peso
						
Lagarde		M39	A=40 B=90	120	18,5	1,40
Cabe Zappator Seppi-Tortella Zanon Enguix		M40	A=40 B=120	90	20,5 16,5 14,5	1,10
Seppi-Sicma Kuhn Maletti Nobili Omarv		M41	A=40 B=120	110	16,5 18,0	1,35
Picursa Bermatingen Humus Sauerburger		M42	A=60 B=150	88	16,5 20,5	1,50
Cosmag Sicma Rinieri Sauerburger		M42/A	A=60 B=150	88	20,5	1,84
Willibald Schots Agric		M43	A=87 B=208	90	20,5	2,24
Rosatello Perfect		M44	A=75 B=200	100	20,5	2,10
Perfect Muratori		M45	A=22 A=17 B=110	100	20,5 25,5	0,68





# MARTILLOS

Máquina	Imagen	Modelo	Medidas	Radio	Orificio	Peso
						
Berti Vigolo Meaat		M50 M51	A=40 B=140	95	16,5 18,5	1,60 0,95
Rousseau Nicolas Norematt Orsi		M100	A=58 B=65	70	25,5	0,51
Jonvues Belafer		M60	A=90 B=150	110	20,5	
Serrat Nobili Rosatello		M70	A=80 B=120	110	20,5	
Bomford Norematt		M101/65 M101/70	A=80 B=75	65 70	19,5	0,70 0,86
Picura Seppi Fae Gandini Berti Caravaggi Ventura		M102/80 M102/110 M108	A=60 B=70	80 110	30,5 36,0	1,48 2,40
Bomford		M109	A=26 B=30 C=16			
Orsi			A=41 B=25 C=11,5			0,118

# MARTILLOS

Máquina	Imagen	Modelo	Medidas	Radio	Orificio	Peso
						
Rosseau Perfect		M109/A	$\text{Ø}=11$ $B=7/16$ $RI=84$	0,085 R=18		
Rosseau Forgiato Orsi		M110				0,186
Bomford Turner Orsi		M11/B M111/T				0,29 0,34
Rondella Washloker		M300	Dientes Z=20 H=16		Ø est 45	0,21
Rondella		M301	Dientes Z=21 H=20		Ø est 65	0,70 0,86
Rondella		M302	Dientes Z=35 H=20		Ø est 90	0,72
Snodo		M303	Dientes Z=37 Ø=56,5		Ø est 80	2,23
Rondella		M304	Dientes Z=72 H=18		Ø est 80	0,68

# MARTILLOS

Máquina	Imagen	Modelo	Medidas	Radio	Orificio	Peso
						
Rondella		M305	Dientes Z=35 H=18		Ø est 50	0,60
Rondella		M306	Dientes Z=35 H=20		Ø est 120	1,16

# MARTILLOS

## Aedes

**63-RM-5-16**

Orig.-Nr. / réf. origine / orig.-part-no.

Gewicht / poids / weight	2,000
--------------------------	-------

## Aedes

**63-RM-5-20**

Orig.-Nr. / réf. origine / orig.-part-no.

Gewicht / poids / weight	2,000
--------------------------	-------

## Agricom

**63-RM-4**

Orig.-Nr. / réf. origine / orig.-part-no.

Gewicht / poids / weight	1,350
--------------------------	-------

## Agricom

**63-RM-8**

Orig.-Nr. / réf. origine / orig.-part-no.

Gewicht / poids / weight	1,150
--------------------------	-------

## Agricom

**63-RM-5-16**

Orig.-Nr. / réf. origine / orig.-part-no.

Gewicht / poids / weight	2,000
--------------------------	-------

## Agricom

**63-RM-8-20**

Orig.-Nr. / réf. origine / orig.-part-no.

Gewicht / poids / weight	1,350
--------------------------	-------

## Agricom

**63-RM-69-20**

Orig.-Nr. / réf. origine / orig.-part-no.

Gewicht / poids / weight	2,550
--------------------------	-------

## Agricom

**63-RM-5-20**

Orig.-Nr. / réf. origine / orig.-part-no.

Gewicht / poids / weight	2,000
--------------------------	-------

## Agricom

**63-RM-6**

Orig.-Nr. / réf. origine / orig.-part-no.

Gewicht / poids / weight	1,600
--------------------------	-------



# MARTILLOS

## Agricom

<b>63-RM-10-20</b>	
Orig.-Nr. / réf. origine / orig.-part-no.	
3001095	
Gewicht / poids / weight	1,850

## Agricom

<b>63-RM-86</b>	
Orig.-Nr. / réf. origine / orig.-part-no.	
3001095	
Gewicht / poids / weight	0,220

## Agrimaster

<b>63-RM-64-14</b>	
Orig.-Nr. / réf. origine / orig.-part-no.	
3001095	
Gewicht / poids / weight	0,680

## Agrimaster

<b>63-RM-64-20</b>	
Orig.-Nr. / réf. origine / orig.-part-no.	
3000548	
Gewicht / poids / weight	0,620

## Agrimaster

<b>63-RM-64</b>	
Orig.-Nr. / réf. origine / orig.-part-no.	
3000548	
Gewicht / poids / weight	0,650

## Agrimaster

<b>63-SEP-51</b>	
Orig.-Nr. / réf. origine / orig.-part-no.	
3000548	
Gewicht / poids / weight	1,630

## Agrimaster

<b>63-RM-70</b>	
Orig.-Nr. / réf. origine / orig.-part-no.	
3002936	
Gewicht / poids / weight	1,060

## Agrimaster

<b>63-M-39</b>	
Orig.-Nr. / réf. origine / orig.-part-no.	
3002936	
Gewicht / poids / weight	1,390

## Agrimaster

<b>63-RM-10-16</b>	
Orig.-Nr. / réf. origine / orig.-part-no.	
3002936	
Gewicht / poids / weight	1,770

# MARTILLOS

## Agrimaster

**63-M-37-16**

Orig.-Nr. / réf. origine / orig.-part-no.

Gewicht / poids / weight	0,650
--------------------------	-------

## Agrimaster

**63-RM-8-20**

Orig.-Nr. / réf. origine / orig.-part-no.

Gewicht / poids / weight	1,120
--------------------------	-------

## Agrimaster

**63-RM-10-20**

Orig.-Nr. / réf. origine / orig.-part-no.

3001119

Gewicht / poids / weight	1,850
--------------------------	-------

## Agrimaster

**63-M-37-14**

Orig.-Nr. / réf. origine / orig.-part-no.

71009

Gewicht / poids / weight	0,730
--------------------------	-------

## Agrimaster

**63-RM-99**

Orig.-Nr. / réf. origine / orig.-part-no.

Gewicht / poids / weight	1,730
--------------------------	-------

## Agromec

**63-M-37-14**

Orig.-Nr. / réf. origine / orig.-part-no.

3001095

Gewicht / poids / weight	0,730
--------------------------	-------

## Agromec

**63-RM-10-20**

Orig.-Nr. / réf. origine / orig.-part-no.

3001095

Gewicht / poids / weight	1,850
--------------------------	-------

## Becchio & Mandrile

**63-RM-46** Serie TS

Orig.-Nr. / réf. origine / orig.-part-no.

CL280

Gewicht / poids / weight	1,450
--------------------------	-------

## Becchio & Mandrile

**63-RM-4-20** Serie FALLOW

Orig.-Nr. / réf. origine / orig.-part-no.

F141

Gewicht / poids / weight	1,313
--------------------------	-------

# MARTILLOS

## Becchio & Mandrile

<b>63-RM-8</b> Serie MEDIUM	
Orig.-Nr. / réf. origine / orig.-part-no. TM152	
Gewicht / poids / weight	1,150

## Becchio & Mandrile

<b>63-RM-4</b>	
Orig.-Nr. / réf. origine / orig.-part-no.	
Gewicht / poids / weight	1,350

## Berti

<b>63-RM-6</b>	
Orig.-Nr. / réf. origine / orig.-part-no. AP-00891	
Gewicht / poids / weight	1,600

## Berti

<b>63-RM-801</b>	
Orig.-Nr. / réf. origine / orig.-part-no.	
Gewicht / poids / weight	0,700

## Berti

<b>63-RM-93</b>	
Orig.-Nr. / réf. origine / orig.-part-no.	
Gewicht / poids / weight	1,810

## Berti

<b>63-RM-30</b>	
Orig.-Nr. / réf. origine / orig.-part-no. AP-00889	
Gewicht / poids / weight	1,080

## Berti

<b>63-RM-6-20</b>	
Orig.-Nr. / réf. origine / orig.-part-no.	
Gewicht / poids / weight	1,430

## Berti

<b>63-RM-74</b>	
Orig.-Nr. / réf. origine / orig.-part-no.	
Gewicht / poids / weight	1,820

## Bomford

<b>63-RM-19</b>	
Orig.-Nr. / réf. origine / orig.-part-no. 03.958.01	
Gewicht / poids / weight	0,715

# MARTILLOS

## Bomford

63-RM-48

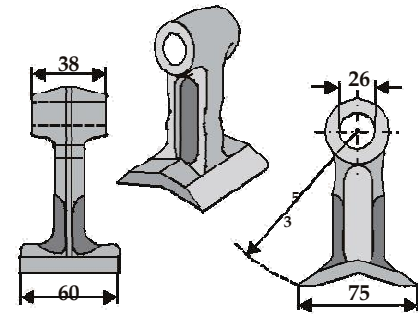

Orig.-Nr. / réf. origine / orig.-part-no.

7314366

Gewicht / poids / weight 0,850

## Bomford

63-BOM-80

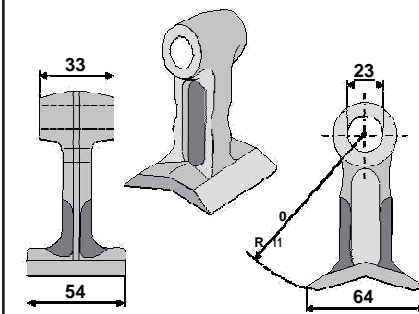

Orig.-Nr. / réf. origine / orig.-part-no.

7191320

Gewicht / poids / weight 0,580

## Bomford

63-RM-25

Typ Merlin

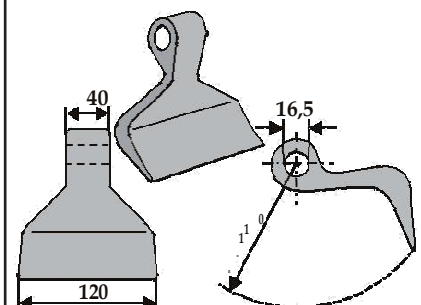

Orig.-Nr. / réf. origine / orig.-part-no.

Gewicht / poids / weight 1,300

## Bomford

63-BOM-81

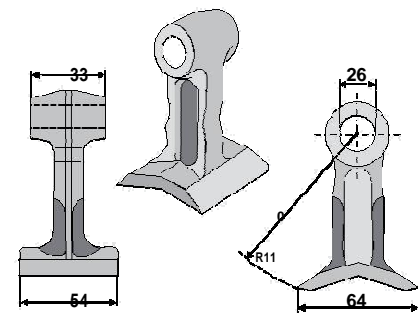

Orig.-Nr. / réf. origine / orig.-part-no.

7198344

Gewicht / poids / weight 0,615

## Bomford

63-RM-45

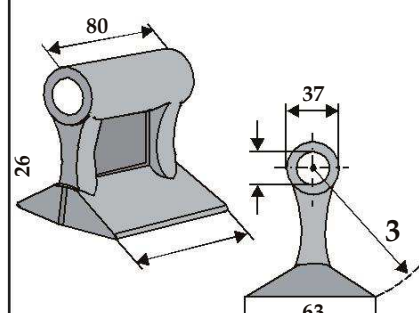

Orig.-Nr. / réf. origine / orig.-part-no.

03958.01

Gewicht / poids / weight 0,840

## Bomford

63-RM-34

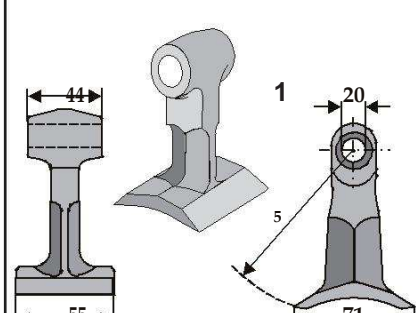

Orig.-Nr. / réf. origine / orig.-part-no.

7770713

Gewicht / poids / weight 0,820

## Bomford

63-RM-17

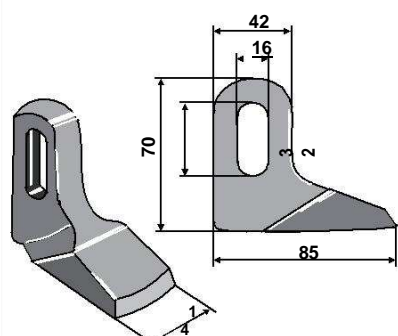

Orig.-Nr. / réf. origine / orig.-part-no.

02.959.01

Gewicht / poids / weight 0,440

## Bomford

63-BOM-83

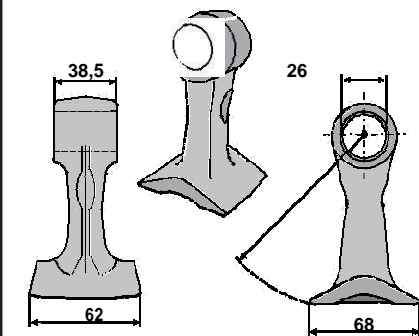

Orig.-Nr. / réf. origine / orig.-part-no.

46399.01

Gewicht / poids / weight 0,750

## Breviglieri

63-RM-6

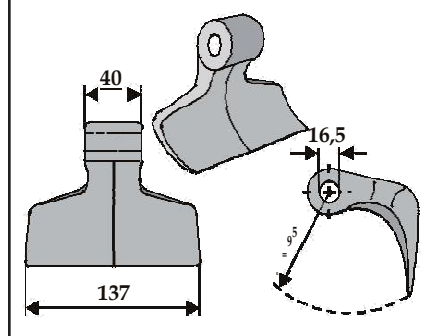

Orig.-Nr. / réf. origine / orig.-part-no.

0056123

Gewicht / poids / weight 1,600

# MARTILLOS

## Cabe (Nuova Cabe)

<b>63-RM-5-16</b>	
Orig.-Nr. / réf. origine / orig.-part-no.	
Gewicht / poids / weight 2,000	

## Cabe (Nuova Cabe)

<b>63-RM-5-20</b>	
Orig.-Nr. / réf. origine / orig.-part-no.	
Gewicht / poids / weight 2,000	

## Cabe (Nuova Cabe)

<b>63-RM-8</b>	
Orig.-Nr. / réf. origine / orig.-part-no.	
222022001	
Gewicht / poids / weight 1,150	

## Cabe (Nuova Cabe)

<b>63-RM-8-20</b>	
Orig.-Nr. / réf. origine / orig.-part-no.	
Gewicht / poids / weight 1,120	

## Cabe (Nuova Cabe)

<b>63-RM-4-20</b>	
Orig.-Nr. / réf. origine / orig.-part-no.	
Gewicht / poids / weight 1,313	

## Cabe (Nuova Cabe)

<b>63-RM-18-20</b>	
Orig.-Nr. / réf. origine / orig.-part-no.	
Gewicht / poids / weight 2,300	

## Calderoni

<b>63-RM-10-20</b>	
Orig.-Nr. / réf. origine / orig.-part-no.	
Gewicht / poids / weight 1,850	

## Chabas

<b>63-RM-5-16</b>	
Orig.-Nr. / réf. origine / orig.-part-no.	
Gewicht / poids / weight 2,000	

## Chabas

<b>63-M-1</b>	
Orig.-Nr. / réf. origine / orig.-part-no.	
Gewicht / poids / weight 2,000	

# MARTILLOS

## Chabas

<b>63-RM-3</b>	
Orig.-Nr. / réf. origine / orig.-part-no.	
Gewicht / poids / weight 1,500	

## Chabas

<b>63-RM-3-20</b>	
Orig.-Nr. / réf. origine / orig.-part-no.	
Gewicht / poids / weight 1,500	

## Mc Connel

<b>63-RM-17</b>	
Orig.-Nr. / réf. origine / orig.-part-no.	
Gewicht / poids / weight 0,440	

## Mc Connel

<b>63-BOM-80</b>	
Orig.-Nr. / réf. origine / orig.-part-no.	
7191320	
Gewicht / poids / weight 0,580	

## Mc Connel

<b>63-RM-17</b>	
Orig.-Nr. / réf. origine / orig.-part-no.	
Gewicht / poids / weight 0,440	

## Mc Connel

<b>63-RM-800</b>	
Orig.-Nr. / réf. origine / orig.-part-no.	
Gewicht / poids / weight 0,760	

## Mc Connel

<b>63-RM-801</b>	
Orig.-Nr. / réf. origine / orig.-part-no.	
Gewicht / poids / weight 0,700	

## Mc Connel

<b>63-RM-78</b>	
Orig.-Nr. / réf. origine / orig.-part-no.	
73-90-276	
Gewicht / poids / weight 0,950	

## Mc Connel

<b>63-RM-48</b>	
Orig.-Nr. / réf. origine / orig.-part-no.	
7314366	
Gewicht / poids / weight 0,850	

# MARTILLOS

## Mc Connel

63-RM-25

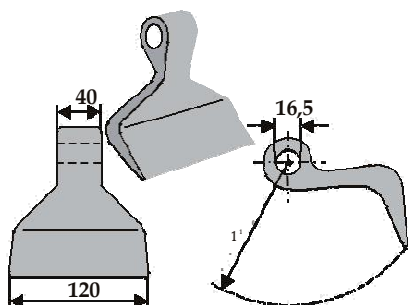

Orig.-Nr. / réf. origine / orig.-part-no.

1026026

Gewicht / poids / weight 1,300

## Mc Connel

63-RM-26

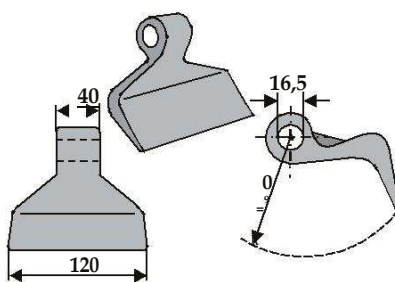

Orig.-Nr. / réf. origine / orig.-part-no.

1026027

Gewicht / poids / weight 1,100

## Cosmag

63-RM-11-20

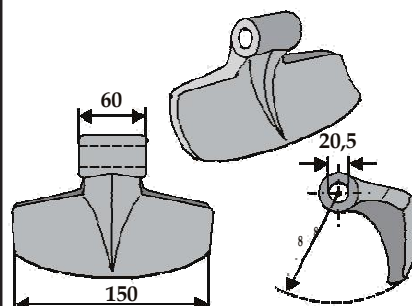

Orig.-Nr. / réf. origine / orig.-part-no.

Gewicht / poids / weight 1,730

## Cosmag

63-M-42-A

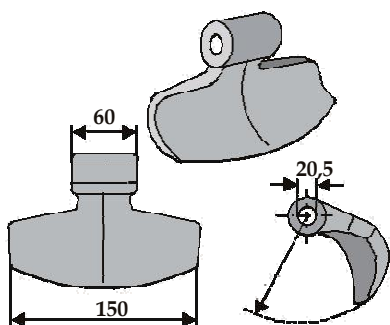

Orig.-Nr. / réf. origine / orig.-part-no.

Gewicht / poids / weight 1,920

## Desvoys

63-RM-4

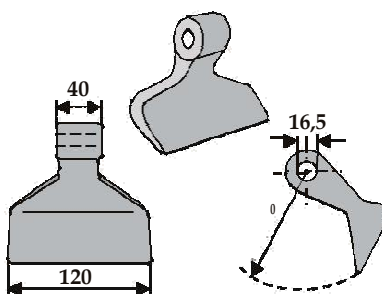

Orig.-Nr. / réf. origine / orig.-part-no.

6061700

Gewicht / poids / weight 1,350

## Desvoys

63-RM-4-20

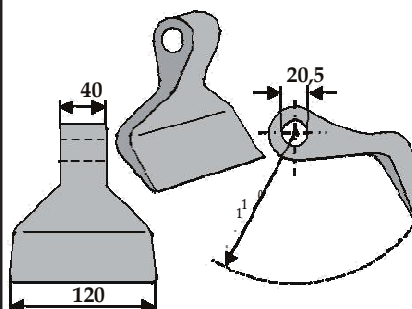

Orig.-Nr. / réf. origine / orig.-part-no.

497

Gewicht / poids / weight 1,440

## Dragone

63-RM-36

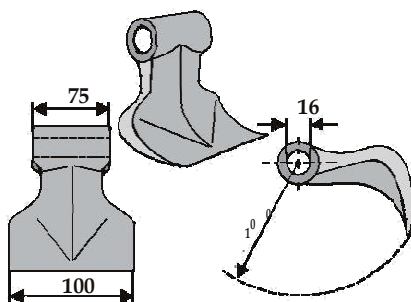

Orig.-Nr. / réf. origine / orig.-part-no.

3045/46

Gewicht / poids / weight 1,340

## Dragone

63-RM-36-18

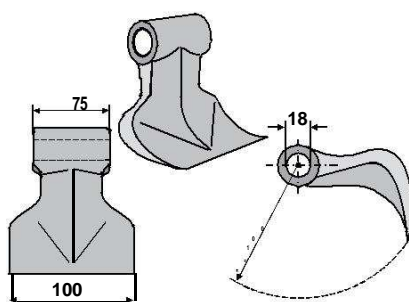

Orig.-Nr. / réf. origine / orig.-part-no.

00003048

Gewicht / poids / weight 1,340

## Dücker

63-GYR-01

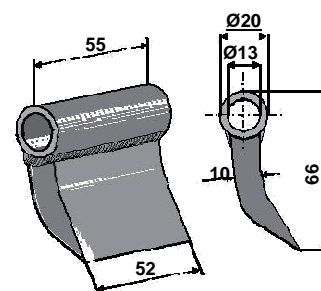

Orig.-Nr. / réf. origine / orig.-part-no.

Gewicht / poids / weight 0,255

# MARTILLOS

## Dücker

<b>63-RM-92</b>	
Orig.-Nr. / réf. origine / orig.-part-no. 945000661	
Gewicht / poids / weight	1,440

## Dücker

<b>63-RM-76</b>	
Orig.-Nr. / réf. origine / orig.-part-no. A-2762	
Gewicht / poids / weight	0,748

## Dücker

<b>63-RM-98</b>	
hammer 	
Orig.-Nr. / réf. origine / orig.-part-no. 945000902	
Gewicht / poids / weight	0,330

## Epoke

<b>63-RM-17</b>	
Orig.-Nr. / réf. origine / orig.-part-no.	
Gewicht / poids / weight	0,440

## F.A.E.

<b>63-SEP-51</b>	
Orig.-Nr. / réf. origine / orig.-part-no.	
Gewicht / poids / weight	1,630

## F.A.E.

<b>63-SEP-52</b>	
Orig.-Nr. / réf. origine / orig.-part-no.	
Gewicht / poids / weight	2,410

## Facma

<b>63-RM-69-18</b>	
Orig.-Nr. / réf. origine / orig.-part-no.	
Gewicht / poids / weight	2,550

## Facma

<b>63-RM-69-22</b>	
Orig.-Nr. / réf. origine / orig.-part-no.	
Gewicht / poids / weight	2,500

## Falc

<b>63-RM-38</b>	
Orig.-Nr. / réf. origine / orig.-part-no. 42.06.82	
Gewicht / poids / weight	2,080



# MARTILLOS

## Falc

63-RM-39

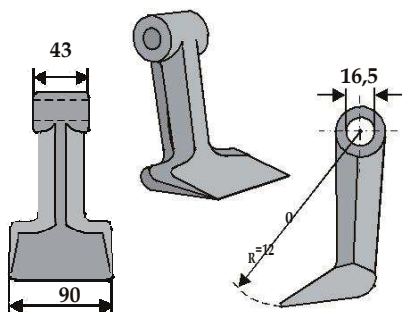

Orig.-Nr. / réf. origine / orig.-part-no.

F450433

Gewicht / poids / weight 1,110

## Falc

63-RM-40

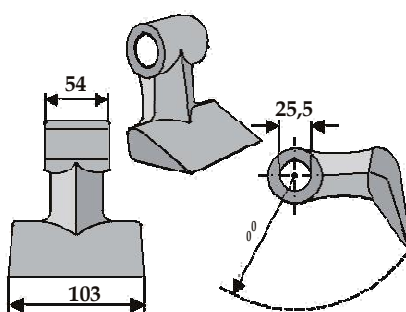

Orig.-Nr. / réf. origine / orig.-part-no.

66 00 00

Gewicht / poids / weight 1,660

## Falconero

63-RM-10-16

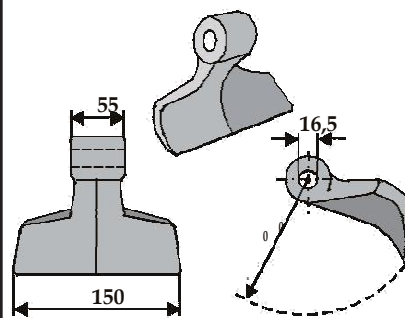

Orig.-Nr. / réf. origine / orig.-part-no.

Gewicht / poids / weight 1,770

## Falconero

63-RM-10-20

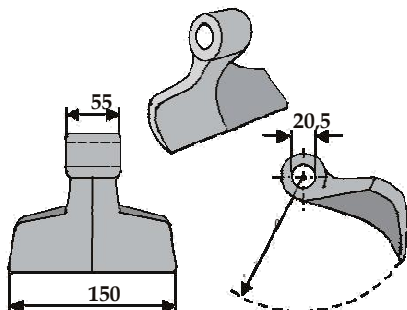

Orig.-Nr. / réf. origine / orig.-part-no.

Gewicht / poids / weight 1,850

## Fehrenbach

63-RM-32

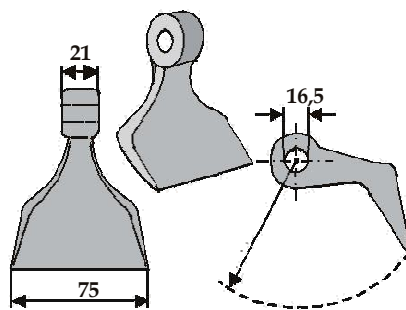

Orig.-Nr. / réf. origine / orig.-part-no.

Gewicht / poids / weight 0,640

## Fehrenbach

63-RM-2

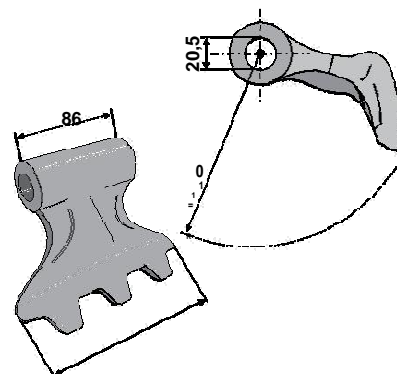

Orig.-Nr. / réf. origine / orig.-part-no.

Gewicht / poids / weight 1,800

## Ferri

63-RM-8-14

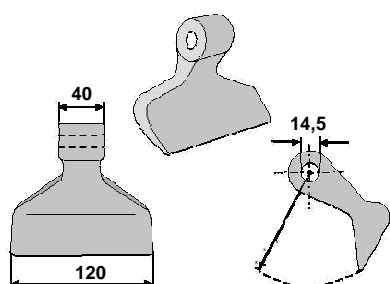

Orig.-Nr. / réf. origine / orig.-part-no.

0901143

Gewicht / poids / weight 1,150

## Ferri

63-RM-7-16

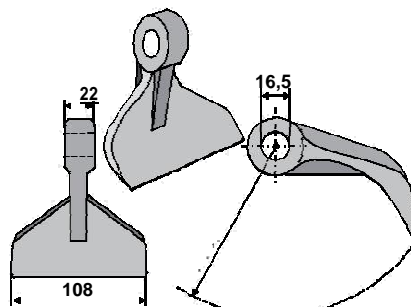

Orig.-Nr. / réf. origine / orig.-part-no.

0901134

Gewicht / poids / weight 0,780

## Ferri

63-RM-20

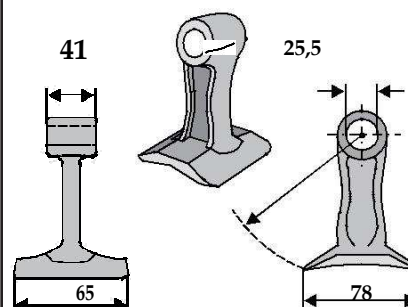

Orig.-Nr. / réf. origine / orig.-part-no.

Gewicht / poids / weight 1,120

# MARTILLOS

**Ferri**

**63-RM-18**

Orig.-Nr. / réf. origine / orig.-part-no.	
0901016	
Gewicht / poids / weight	2,350

**Ferri**

**63-FEI-27**

Orig.-Nr. / réf. origine / orig.-part-no.	
0901010	
Gewicht / poids / weight	1,000

**Ferri**

**63-RM-47**

Orig.-Nr. / réf. origine / orig.-part-no.	
0901048	
Gewicht / poids / weight	1,270

**Fischer**

**63-M-1**

Orig.-Nr. / réf. origine / orig.-part-no.	
Gewicht / poids / weight	2,000

**Fischer**

**63-RM-5-16**

Orig.-Nr. / réf. origine / orig.-part-no.	
Gewicht / poids / weight	2,000

**Fischer**

**63-RM-3**

Orig.-Nr. / réf. origine / orig.-part-no.	
Gewicht / poids / weight	1,500

**Forigo-Roteritalia**

**63-RM-4-20**

Orig.-Nr. / réf. origine / orig.-part-no.	
Gewicht / poids / weight	1,313

**Gestin**

**63-RM-1-16**

Orig.-Nr. / réf. origine / orig.-part-no.	
Gewicht / poids / weight	1,450

**Gestin**

**63-RM-1-20**

Orig.-Nr. / réf. origine / orig.-part-no.	
Gewicht / poids / weight	1,430

# MARTILLOS

## Gestin

**63-RM-11-16**

Orig.-Nr. / réf. origine / orig.-part-no.

Gewicht / poids / weight	1,750
--------------------------	-------

## Gestin

**63-RM-11-20**

Orig.-Nr. / réf. origine / orig.-part-no.

Gewicht / poids / weight	1,730
--------------------------	-------

## Gilbers

**63-RM-45**

Orig.-Nr. / réf. origine / orig.-part-no.

Gewicht / poids / weight	0,840
--------------------------	-------

## Gilbers

**63-RM-4-20**

Orig.-Nr. / réf. origine / orig.-part-no.

802-042

Gewicht / poids / weight	1,313
--------------------------	-------

## Herder

**63-WIL-51**

Orig.-Nr. / réf. origine / orig.-part-no.

95722004

Gewicht / poids / weight	2,240
--------------------------	-------

## HMF FREI

**63-M-1**

Orig.-Nr. / réf. origine / orig.-part-no.

Gewicht / poids / weight	2,000
--------------------------	-------

## HMF FREI

**63-RM-3**

Orig.-Nr. / réf. origine / orig.-part-no.

Gewicht / poids / weight	1,500
--------------------------	-------

## HMF FREI

**63-RM-5-16**

Orig.-Nr. / réf. origine / orig.-part-no.

Gewicht / poids / weight	2,000
--------------------------	-------

## HMF FREI

**63-RM-32**

Orig.-Nr. / réf. origine / orig.-part-no.

Gewicht / poids / weight	0,640
--------------------------	-------

# MARTILLOS

## Howard

<b>63-RM-25</b>	
Orig.-Nr. / réf. origine / orig.-part-no.	
222022001	
Gewicht / poids / weight	1,350

## Howard

<b>63-RM-26</b>	
Orig.-Nr. / réf. origine / orig.-part-no.	
222022001	
Gewicht / poids / weight	1,150

## Humus

<b>63-RM-1-16</b>	
Orig.-Nr. / réf. origine / orig.-part-no.	
59091399	
Gewicht / poids / weight	1,450

## Humus

<b>63-RM-1-20</b>	
Orig.-Nr. / réf. origine / orig.-part-no.	
45165116D	
Gewicht / poids / weight	1,430

## Hymach

<b>63-RM-17</b>	
Orig.-Nr. / réf. origine / orig.-part-no.	
Gewicht / poids / weight	0,440

## JNO

<b>63-RM-82</b>	
Orig.-Nr. / réf. origine / orig.-part-no.	
Gewicht / poids / weight	0,985

## Kuhn

<b>63-RM-4</b>	
Orig.-Nr. / réf. origine / orig.-part-no.	
6061700	
Gewicht / poids / weight	1,350

## Kuhn

<b>63-RM-101</b>	
Orig.-Nr. / réf. origine / orig.-part-no.	
6061900	
Gewicht / poids / weight	0,900

## Kuhn

<b>63-RM-7-16</b>	
Orig.-Nr. / réf. origine / orig.-part-no.	
Gewicht / poids / weight	0,780

# MARTILLOS

## Kuhn

<b>63-RM-2</b>	
Orig.-Nr. / réf. origine / orig.-part-no. 6060007	
Gewicht / poids / weight	1,800

## Kuhn

<b>63-RM-46</b>	
Orig.-Nr. / réf. origine / orig.-part-no. 6061699	
Gewicht / poids / weight	1,330

## Kverneland-Maletti

<b>63-RM-10-16</b>	
Orig.-Nr. / réf. origine / orig.-part-no.	
Gewicht / poids / weight	1,770

## Kverneland-Maletti

<b>63-RM-66</b>	
Orig.-Nr. / réf. origine / orig.-part-no. 6303076	
Gewicht / poids / weight	1,310

## Kverneland-Maletti

<b>63-RM-4</b>	
Orig.-Nr. / réf. origine / orig.-part-no.	
Gewicht / poids / weight	1,350

## Lagarde

<b>63-M-39</b>	
Orig.-Nr. / réf. origine / orig.-part-no.	
Gewicht / poids / weight	1,390

## Lagarde

<b>63-RM-67</b>	
Orig.-Nr. / réf. origine / orig.-part-no.	
Gewicht / poids / weight	1,510

## Lagarde

<b>63-RM-804</b>	
Orig.-Nr. / réf. origine / orig.-part-no.	
Gewicht / poids / weight	0,950

## Maschio

<b>63-RM-8-20</b>	
Orig.-Nr. / réf. origine / orig.-part-no.	
Gewicht / poids / weight	1,120

# MARTILLOS

## Maschio

**63-RM-10-20**

Orig.-Nr. / réf. origine / orig.-part-no.

Gewicht / poids / weight	1,850
--------------------------	-------

## Maschio

**63-RM-4-20**

Orig.-Nr. / réf. origine / orig.-part-no.

Gewicht / poids / weight	1,313
--------------------------	-------

## Maschio

**63-RM-66**

Orig.-Nr. / réf. origine / orig.-part-no.  
T21004025

Gewicht / poids / weight	1,310
--------------------------	-------

## Maschio

**63-RM-1-20**

Orig.-Nr. / réf. origine / orig.-part-no.  
03400405

Gewicht / poids / weight	1,430
--------------------------	-------

## Maschio

**63-RM-85**

Orig.-Nr. / réf. origine / orig.-part-no.  
03400405

Gewicht / poids / weight	1,235
--------------------------	-------

## M.E.A.A.T.

**63-RM-4**

Orig.-Nr. / réf. origine / orig.-part-no.

Gewicht / poids / weight	1,350
--------------------------	-------

## M.E.A.A.T.

**63-RM-74**

Orig.-Nr. / réf. origine / orig.-part-no.

Gewicht / poids / weight	1,820
--------------------------	-------

## M.E.A.A.T.

**63-RM-6**

Orig.-Nr. / réf. origine / orig.-part-no.

Gewicht / poids / weight	1,600
--------------------------	-------

## M.E.A.A.T.

**63-RM-6-18**

Orig.-Nr. / réf. origine / orig.-part-no.

Gewicht / poids / weight	1,560
--------------------------	-------

# MARTILLOS

## Meritano

**63-RM-37**

Orig.-Nr. / réf. origine / orig.-part-no.

Gewicht / poids / weight 1,310

## Mulag

**63-RM-76**

Orig.-Nr. / réf. origine / orig.-part-no.

48980000

Gewicht / poids / weight 0,748

## Mulag

**63-RM-14**

Orig.-Nr. / réf. origine / orig.-part-no.

TM60-07-0223

Gewicht / poids / weight 0,600

## Muratori

**63-RM-10-16**

Orig.-Nr. / réf. origine / orig.-part-no.

Gewicht / poids / weight 1,770

## Muratori

**63-RM-10-20**

Orig.-Nr. / réf. origine / orig.-part-no.

Gewicht / poids / weight 1,850

## Muratori

**63-RM-7-14M**

Orig.-Nr. / réf. origine / orig.-part-no.

Gewicht / poids / weight 0,830

## Müthing

**63-RM-30**

Orig.-Nr. / réf. origine / orig.-part-no.

2405003055

Gewicht / poids / weight 1,080

## Nicolas

**63-RM-14**

Orig.-Nr. / réf. origine / orig.-part-no.

Gewicht / poids / weight 0,600

## Nobili

**63-RM-2**

Orig.-Nr. / réf. origine / orig.-part-no.

Gewicht / poids / weight 1,800

# MARTILLOS

## Nobili

<b>63-RM-4</b>	
Orig.-Nr. / réf. origine / orig.-part-no.	
Gewicht / poids / weight 1,350	

## Nobili

<b>63-RM-24</b>	
Orig.-Nr. / réf. origine / orig.-part-no.	
Gewicht / poids / weight 1,075	

## Nobili

<b>63-RM-46</b>	
Orig.-Nr. / réf. origine / orig.-part-no.	
Gewicht / poids / weight 1,330	

## Nobili

<b>63-RM-43</b>	
Orig.-Nr. / réf. origine / orig.-part-no.	
Gewicht / poids / weight 1,450	

## Noremat

<b>63-RM-14</b>	
Orig.-Nr. / réf. origine / orig.-part-no.	
1.39.207	
Gewicht / poids / weight 0,600	

## Noremat

<b>63-RM-800</b>	
Orig.-Nr. / réf. origine / orig.-part-no.	
103041	
Gewicht / poids / weight 0,760	

## Noremat

<b>63-RM-17</b>	
Orig.-Nr. / réf. origine / orig.-part-no.	
100113	
Gewicht / poids / weight 0,440	

## Oehler

<b>63-RM-6</b>	
Orig.-Nr. / réf. origine / orig.-part-no.	
Gewicht / poids / weight 1,600	

## OMARV

<b>63-RM-4-18</b>	
Orig.-Nr. / réf. origine / orig.-part-no.	
CL00325	
Gewicht / poids / weight 1,350	



# MARTILLOS

## OMARV

**63-RM-4**

Orig.-Nr. / réf. origine / orig.-part-no.  
CL00323

Gewicht / poids / weight	1,350
--------------------------	-------

## OMARV

**63-RM-6-18**

Orig.-Nr. / réf. origine / orig.-part-no.

Gewicht / poids / weight	1,560
--------------------------	-------

## OMARV

**63-RM-7-14**

Orig.-Nr. / réf. origine / orig.-part-no.

Gewicht / poids / weight	0,830
--------------------------	-------

## OMARV

**63-RM-7-16**

Orig.-Nr. / réf. origine / orig.-part-no.

Gewicht / poids / weight	0,780
--------------------------	-------

## Orsi

**63-BOM-81**

Orig.-Nr. / réf. origine / orig.-part-no.

Gewicht / poids / weight	0,615
--------------------------	-------

## Orsi

**63-RM-20**

Orig.-Nr. / réf. origine / orig.-part-no.

Gewicht / poids / weight	1,120
--------------------------	-------

## Orsi

**63-RM-48**

Orig.-Nr. / réf. origine / orig.-part-no.

Gewicht / poids / weight	0,850
--------------------------	-------

## Orsi

**63-RM-86**

Orig.-Nr. / réf. origine / orig.-part-no.

Gewicht / poids / weight	0,220
--------------------------	-------

## Orsi

**63-RM-99**

Orig.-Nr. / réf. origine / orig.-part-no.

Gewicht / poids / weight	1,730
--------------------------	-------

# MARTILLOS

## Orsi

<b>63-RM-10-20</b>	
Orig.-Nr. / réf. origine / orig.-part-no.	
Gewicht / poids / weight	1,850

## Orsi

<b>63-M-37-14</b>	
Orig.-Nr. / réf. origine / orig.-part-no.	
Gewicht / poids / weight	0,730

## Palladino

<b>63-M-1</b>	
Orig.-Nr. / réf. origine / orig.-part-no.	
Gewicht / poids / weight	2,000

## Palladino

<b>63-RM-3</b>	
Orig.-Nr. / réf. origine / orig.-part-no.	
Gewicht / poids / weight	1,500

## Palladino

<b>63-RM-95</b>	
Orig.-Nr. / réf. origine / orig.-part-no.	
Gewicht / poids / weight	1,580

## Pegoraro

<b>63-RM-3</b>	
Orig.-Nr. / réf. origine / orig.-part-no.	
Gewicht / poids / weight	1,500

## Perfect

<b>63-RM-7-16</b>	
Orig.-Nr. / réf. origine / orig.-part-no.	
Gewicht / poids / weight	0,780

Orig.-Nr. / réf. origine / orig.-part-no.	
Gewicht / poids / weight	

# CUCHILLAS

MARCA	ALTURA	GRUESO	ORIFICIO
<b>AGRIMASTER</b>			
AGRM 00001	150	60x10	25,5
AGRM 0002	120	35x4	14,5
AGRM 0003	120	40x8	20,5
AGRM 0004		60x10	25,5
<b>ARTEMACCANICA</b>			
ARTE 0001	160	60x8	27
<b>FERRI</b>			
FERI 0001	235	60x8	25,5
FERI 0002	80	40x5	14x29
FERI 0003	90	40x8	14x29
FERI 0004	100	40x8	14x29
FERI 0005		40x5	14x29
FERI 0011	240	60x8	25,5
FERI 0026	150	60x8	25,5
<b>FALC</b>			
FALC 0010	200	60x10	25,5
FALC 0011		60x10	25,5
FALC 0012	135	40x8	16,5
<b>GIMAC</b>			
GIMA 0015	100	40x6	17x35
GIMA 0016		35x6	17
GIMA 0041	150	35x6	17
<b>MALETTI</b>			
MALE 0011	128	30x4	10,5
MALE 0012	130	40x5	14,5
MALE 0013	205	50x10	16,5
<b>MASCHIO</b>			
MASC 0051	150	60x10	20,5
<b>TAARUP</b>			
TAAR 0002	150	70x7	13,5
TAAR 0007	210	60x7	29
TAAR 0008	210	60x7	29
<b>ZAPPATOR</b>			
ZAPP	130	60x10	20,5
<b>BONFORT</b>			
BONFORT SODIUM			
<b>MEARELLI-MEAAT</b>			
MEAT 0012	200	60x10	25,5
MEAT 0013	200(L)	60x10	25,5
MEAT 0014		60x10	25,5
MEAT 0015	110	50x10	16,5
MEAT 0016	110	50x10	18,5
<b>MEO</b>			
MEO 0007	160	60x8	30,5

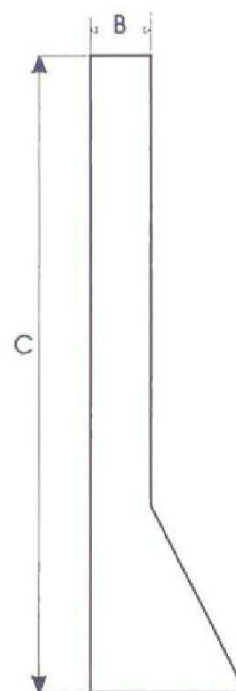
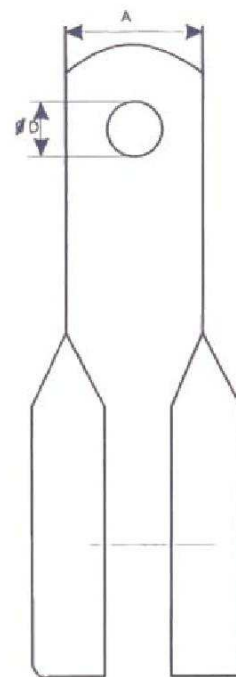





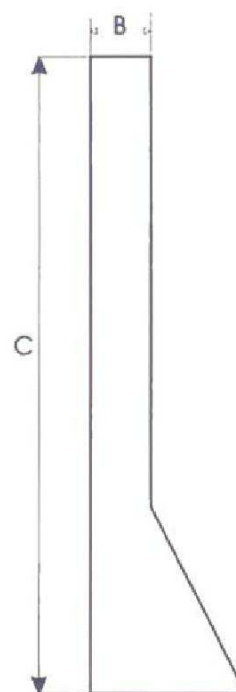
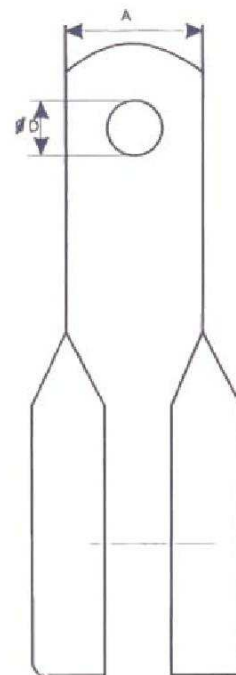



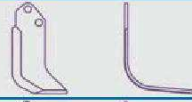
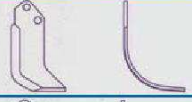

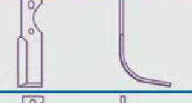

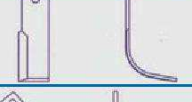
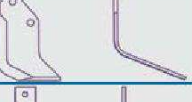

# CUCHILLAS











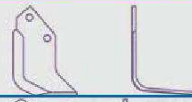
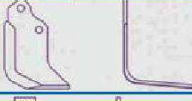

MARCA	ALTURA	GRUESO	ORIFICIO
<b>MURATORI</b>			
MURA 0031	150	60x10	25,5
MURA 0032	120	35x5	14,5
MURA 0033	117	40x8	20,5
<b>NOBILI</b>			
NOBI 0001	235	60x8	25,5
NOBI 0008	175	40x8	16,5
NOBI 0010	200	60x10	25,5
NOBI 0021	200(L)	60x10	25,5
NOBI 0022		60x10	25,5
NOBI 0023	190	60x8	16,5
NOBI 0038	135	40x8	14x31
NOBI 0044	90	35x6	16,5
NOBI 0045	175	35x6	16,5
NOBI 0046	215	35x6	16,5
NOBI 0047		40x8	16,5
NOBI 0048	175	40x8	16,5
NOBI 0049	135	45x8	16,5
<b>ORSI</b>			
ORSI 0001	135	40x8	16,5
<b>PROCOMAS</b>			
PROC 0001	125	40x6	16,5
PROC 0002	140	60x6	25,5
<b>SICMA S.R.L.</b>			
SICM 0032	195	60x8	25,5
SICM 0044	90	35x6	14x31
SICM 0045	200(L)	60x8	25,5
SICM 0046	130(L)	60x8	25,5
SICM 0047		60x8	25,5

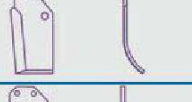
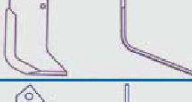
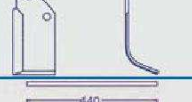

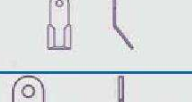
# CUCHILLAS

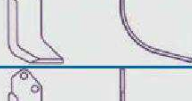
Referencia	Máquina	Esquema	Dimensiones Pletina	Agujeros	Dist. interejes	Peso	Ud. caja	Marca
10	TODO		H= 160 C= 125	60x7	12,5	35	0,680	25
10-C	AL/AFMU ALD		H= 158 C= 135	60x6	11,75	35	0,575	25
10-L	AFMU		H= 150 C= 135	60x6	11,75	35	0,625	25
100 (35x6)	DS10		H= 221 C= 90	35x6	10,5 COLISO	66-72	0,400	40
100 (40x6)	SICILIA		H= 221 C= 82	40x6	10,5 COLISO	66-72	0,430	40
101	---		H= 222 C= 115	60x7	13,25	---	0,925	20
107	VLM/VM		H= 200 C= 140	75x8	13,25	57	1,130	15
109	M-7		H= 242 C= 80	40x7	10,5	79	0,550	20
11-E	JRN/JRM		H= 164 C= 123	60x6	13,25	35	0,550	25
135	DM/VM		H= 194 C= 138	80x7	13,25	57	0,990	20
135-E			H= 200 C= 135	80x7	13,25	57	1,075	20
172-C	---		H= 170 C= 85	50x6	10,5	35	0,470	30
178	3000 3001		H= 212 C= 80	40x5	8,5	70	0,350	50
198	595 595-42		h= 195 c= 102	60x6	12,5	42	0,590	30
198-C	FRESA 595		H= 183 C= 90	60x6	12,5	42	0,535	30
198-E	595 LEVANTE		H= 180 C= 92	60x6	12,5	42	0,505	30

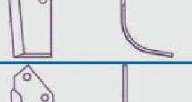
# CUCHILLAS







Referencia	Máquina	Esquema	Dimensiones Pletina	Agujeros	Dist. interejes	Peso	Ud. caja	Marca
198-ALFE	S.315		H= 143 C= 90	50x6	10,5	25	0,385	30
2	AR		H= 180 C= 138	80x7	13,25	57	1,130	15
207-M	AF AMS/AFMD		H=175 C= 135	75x6	11,75	57	0,870	20
214-E	ESPECIAL ITALIA 528 FRESA 588		H= 236 C= 90	40x6	10,5	79	0,470	40
234	EXPORT-518		H= 260 C= 106	55x6	12,5	100	0,870	25
253-B	S.320		H= 260 C= 102	50x7	12,5	90	0,705	15
254-CTF	913		H= 165 C= 50	50x6	10,5	32	0,330	30
64-A	1900 8900 9900		H= 200 C= 110	70x6	10,5x3	60 35,5-35,5	0,830	25
8-H	H-25 (ANTIGUA)		H= 158 C= 125	60x7	12,5	42	0,730	25
AGM-02	ESTANDARD		X= 80 Y= 212	440x6	20.20.20 10x23	---	2,500	5
AGM-03	---		H= 110 C= 50	40x8	20,5	---	0,300	20
AGT-03-DC	T/TS		H= 145 C= 60	60x10	26	---	0,710	20
AGT-04-C	AV		H= 177 C= 108	60x6	11,75	35	0,585	30
AGT-04-CL	AV		H= 177 C= 138	60x6	11,75	35	0,670	30
AGT-10	AM/KD		H= 195 C= 143	100x10	16,5	75	1,920	10
AGT-12	AM/KD		H= 195 C= 143	100x12	16,5	75	2,350	10

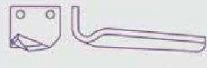
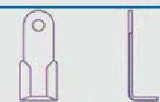
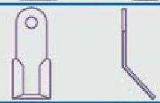
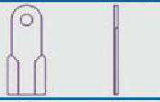
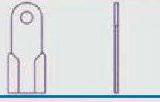

# CUCHILLAS



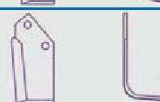
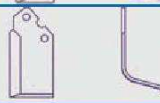
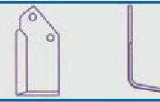
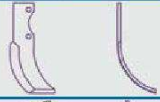

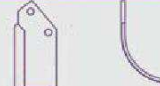





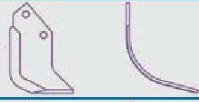
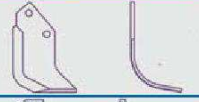

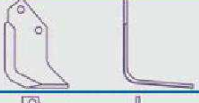
Referencia	Máquina	Esquema	Dimensiones Pletina	Agujeros	Dist. interejes	Peso	Ud. caja	Marca
AGT-12-L	ASR		H= 158 C= 148	80x8	13,25	57	1,230	15
AGT-13-C	ASR/AM		H= 190 C= 148	85x9	16,5	57	1,430	15
AGT-14-C	AV		H= 250 C= 105	40x8	11,75	114	0,725	20
AGT-16-R	GT/ART/GMT GRT/ALT		H= 218	50x12	16,5	50	0,910	15
AMA-03	KL-KP		H= 120 C= 55	40x8	20,5	---	0,300	20
BCS-01	B4		H= 165 C= 55	30x5	8,5	55	0,210	50
BCS-06	735 705 PATERNO		H= 122 C= 50	40x6	10,5	26	0,250	50
BCS-08	705		H= 148 C= 74	50x6	10,5	40	0,375	30
BCS-10	745T SICILIA		H= 173 C= 74	60x7	12,5	46	0,650	20
BER-16	S.315		H= 155 C= 82	50x6	10,5	28	0,410	20
BER-22	S.306		H= 170 C=72	30x6	8,5	56	0,270	20
BRU-03	---		H= 215 C= 60	35x6	9	70	0,370	20
CEL-25	---		H= 120 C= 55	50x10	16,5	---	0,470	20
DER-38	525495 525494		H= 270	110x12	16,5	68	2,100	5
DER-39	525394 525395		H= 300	110x16	16,5	68	2,800	5
DER-50	DIAMANTE		H= 280	90x10	17	50	1,380	5

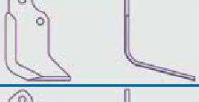
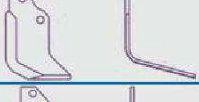
# CUCHILLAS

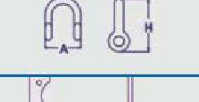
Referencia	Máquina	Esquema	Dimensiones Pletina	Agujeros	Dist. interejes	Peso	Ud. caja	Marca
DER-51	---		H= 280 90x12	17	60	1,960	10	
DER-52	FVL/FVM FVP		H= 300 100x12	17	60	1,960	5	
FEI-03	L		H= 250 C= 68 60x8	25,5	---	1,150	20	
FEI-04	TIPO CORTO		H= 140 C= 60 60x8	25,5	---	0,530	20	
FEI-09	RECTO		H= 250 60x8	25,5	---	0,860	20	
FEI-12			H= 230 60x8	25,5	---	0,780	20	
FEI-13	COLISO TIPO CORTO		H= 80 C= 45 40x8	30x14	---	0,210	20	
FEI-15	COLISO TIPO LARGO		H= 103 C= 45 40x8	30x14	---	0,250	100	
FEI-31	GRILLETE		H= 65 A= 48 ---	11,5	---	0,130	10	
GAL-01	FN FL-O/FL-OH		H= 245 C= 103 60x8	10,5	48	1,080	15	
H-5/8	SRF/SRG		H= 170 C= 145 80x10	16,5	51	1,445	10	
HER-01	TC		H= 182 C= 128 80x7	13,25	57	1,000	15	
HER-08	STC		H= 167 C= 106 60x7	13,25	44	0,710	25	
HON-380	---		H= 195 C= 80 35x5	8,5	70	0,280	50	
JAP-01	---		R= 220 C= 60 45x8	10,5	---	0,690	20	
JOP-01	JF-O JF-R/JF-OD 7032		H= 170 C= 106 60x6	12,5	46	0,550	25	

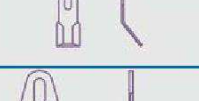

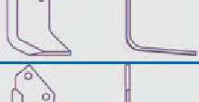
# CUCHILLAS

Referencia	Máquina	Esquema	Dimensiones Pletina	Agujeros	Dist. interejes	Peso	Ud. caja	Marca
JOP-02	JF-1 7334-A		H= 180 C= 137	70x6	13,25	57	0,820	20
JOP-04	JF-2R 22034		H= 202 C= 142	80x8	14,75	57	1,320	15
KUH 01/02	CULTILABOUR		H= 205	50x12	16,5	50	0,890	10
MAL-03	B-ELIC		H= 207 C= 115	80x8	14,5	46	1,290	10
MAS-01	---		H= 190 C= 120	60x6	13,25	44	0,605	20
MAS-03	B/C/SC		H= 225 C= 142	80x8	14,5	56	1,300	10
MAS-37	U		H= 196 C= 135	80x7	14,5	48	0,980	10
MUR-06	MA-MS2 P		H= 180 C= 110	60x6	12,5	46	0,650	10
ORS-01	---		H= 140 C= 60	60x8	16,5	---	0,520	20
ORS-02	GRILLETE		H= 65 C= 48	---	12,5	---	0,130	10
PAB-01	G2/G51/G62/HP5		H= 195 C= 70	35x6	8,5	73	0,350	20
R-22	FRESA 22		H= 186 C= 80	45x5	10,5 COLISO	30-36	0,395	35
ROU-02	---		H= 101 C= 42	40x5	26x14	---	0,150	10
ROU-03	---		H= 100 C= 40	45x9	38x16	---	0,250	100
SIM-09	ST		H= 180 C= 130	80x7	14,5	50	0,980	10
SOV-06	MS3 P180 MS2 140-160		H= 175 C= 108	70x7	14,5	46	0,980	20

