

**Wences**

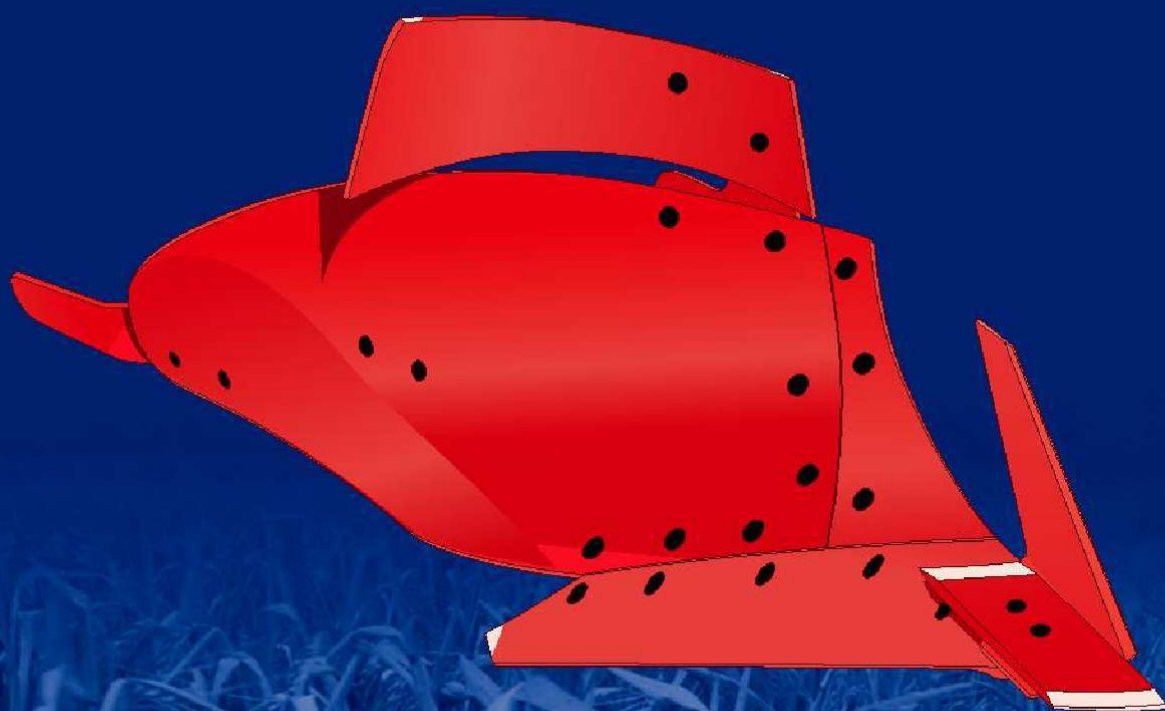

*Catalogo*

# **Suministros Industriales Wences**



[www.suministrosindustrialeswences.com](http://www.suministrosindustrialeswences.com)

Printed 01/2015







Bolts and nuts are now sold separately in bolt boxes (BK no).

Here is our new Bolt box no. added to our catalogue, this makes it easy to find the right Bolt box no. for the Article no. when you order your parts. See page 80 in our catalogue for more information.

Parts to fit

## LEMKEN BS 42 ploughbodies

**Bolt box no. Article-no. Designation**

Mouldboards, shins and accessories

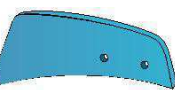
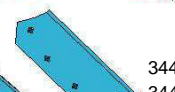
567MOL	3470860			BK009	3470860	Turbo-trashboard R
	3470861			BK009	3470861	Turbo-trashboard L
568MOL	3444030	3444020	3444010	BK141	469MOL-R	Stay with support R
	3444031	3444021	3444011	BK141	469MOL-L	Stay with support L
					4695600	Stay R
					4695601	Stay L
					567MOL	Support for stay, short
					568MOL	Support for stay, long
				BK007	3451002	Shin R (10mm)
				BK007	3451003	Shin L (10mm)
				BK010	3451010	Shin R (8mm)
				BK010	3451011	Shin L (8mm)
				BK172	3444010	Mouldboard stripe R
				BK172	3444011	Mouldboard stripe L
				BK172	3444020	Mouldboard stripe R
				BK172	3444021	Mouldboard stripe L
				BK172	3444030	Mouldboard stripe R
				BK172	3444031	Mouldboard stripe L
				BK173	3444042	Mouldboard stripe R
				BK173	3444043	Mouldboard stripe L
				BK006	3444012	Rev. top stripe R
				BK006	3444013	Rev. top stripe L
				BK140	4671002	Frog R
				BK140	4671003	Frog L



Parts to fit:

## GREGOIRE-BESSON ploughs

### Bolt box no. Article-no. Designation

#### Mouldboard and shin

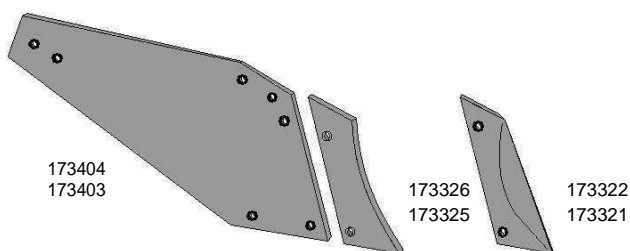

173404 Mouldboard R  
173403 Mouldboard L

BK052 173326 Shin R  
BK052 173325 Shin L  
BK052 173322 Shin R  
BK052 173321 Shin L

#### Shares, points and accessories

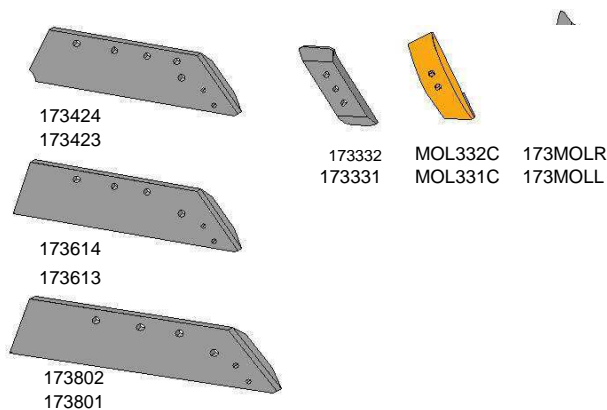

BK114 173424 EUROSHARE 14" R  
BK114 173423 EUROSHARE 14" L  
BK113 173614 EUROSHARE 16" R  
BK113 173613 EUROSHARE 16" L  
BK113 173802 EUROSHARE 18" R  
BK113 173801 EUROSHARE 18" L  
BK095 173332 EUROPOINT Rev. R  
BK095 173331 EUROPOINT Rev. L  
BK096 173MOL R Share knife R (173324)  
BK096 173MOL L Share knife L (173323)  
BK095 MOL332C EUROCARBIDE M3 point R  
BK095 MOL331C EUROCARBIDE M3 point L

#### Skim shares

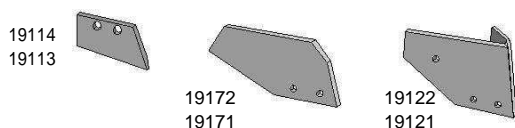

BK052 19114 Skim shares R  
BK052 19113 Skim shares  
BK052 19172 Skim mouldboard R  
BK052 19171 Skim mouldboard L  
19122 Skim mouldboard R  
19121 Skim mouldboard L

#### Landsides

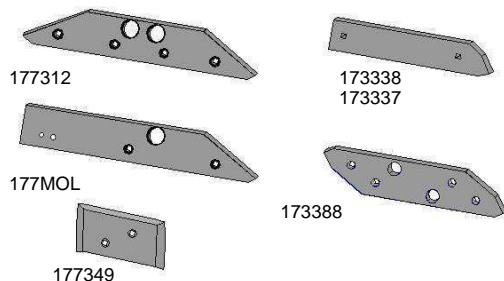

BK036 177312 Landside R&L  
BK036 177MOL Landside R&L  
BK036 173338 Landside, short R  
BK036 173337 Landside, short L  
BK036 173388 Landside, rev. R&L  
177349 Wearing plate, rev. R&L

#### Parts to mount on landsides

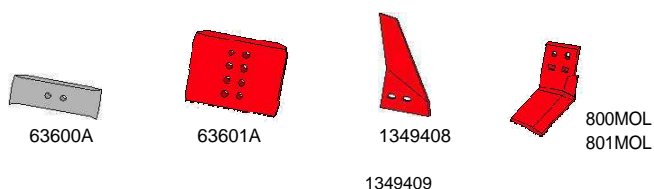

BK094 63600A Wearing plate, rev. R&L  
BK094 63601A Wearing plate, rev. R&L  
BK052 1349408 Sword coulter R  
BK052 1349409 Sword coulter L  
BK096 800MOL Subsoiler blade R  
BK096 801MOL Subsoiler blade L



Parts to fit

## KUHN RH/RLM ploughbodies

**Bolt box no. Article-no. Designation**

### Shin

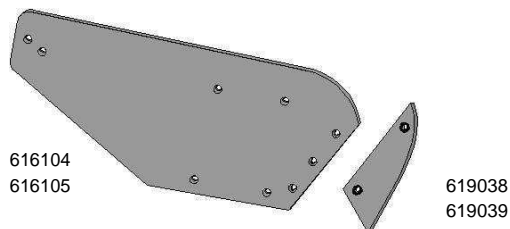

	616104	Mouldboard R
	616105	Mouldboard L
BK069	619038	Shin R
BK069	619039	Shin L

### Shares, points and accessories

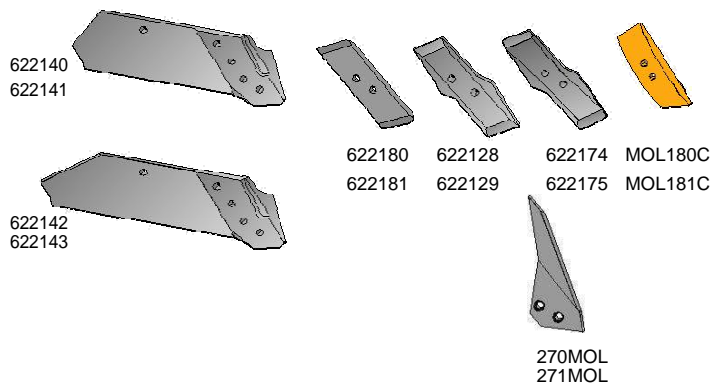

BK095	622180	EUROPOINT rev. R
BK095	622181	EUROPOINT rev. L
BK095	MOL180C	EUROCARBIDE M3 point R
BK095	MOL181C	EUROCARBIDE M3 point L
BK095	622128	EUROPOINT Z- R
BK095	622129	EUROPOINT Z- L
BK095	622174	EUROPOINT Z- reinforc. R
BK095	622175	EUROPOINT Z- reinforc. L
BK112	622140	Share f/rev. point 14" R
BK112	622141	Share f/rev. point 14" L
BK112	622142	Share f/rev. point 16" R
BK112	622143	Share f/rev. point 16" L
BK095	270MOL	Share knife R
BK095	271MOL	Share knife L

### Landsides

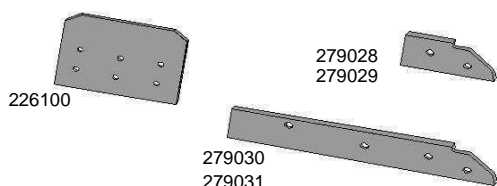

BK069	279028	Landside, short R
BK069	279029	Landside, short L
BK057	279030	Landside, long R
BK057	279021	Landside, long L
	226100	Steering plate R&L

Parts to fit:

## KUHN PP and C ploughbodies

### Landsides



BK099	223122	Landside, rev. R&L
BK099	279140	Landside, rev. R&L
BK098	279138	Skim point R
BK098	279139	Skim point L

### Parts to mount on landsides

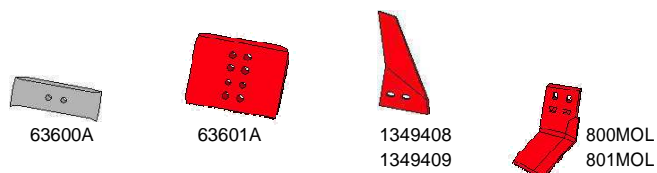

BK094	63600A	Wearing plate, rev. R&L
BK094	63601A	Wearing plate, rev. R&L
BK052	1349408	Sword coulter R
BK052	1349409	Sword coulter L
BK096	800MOL	Subsoiler blade R
BK096	801MOL	Subsoiler blade L



Parts to fit:

## KUHN H4 and H6 ploughbodies

### Bolt box no. Article-no. Designation

#### Mouldboards, shins and accessories

648102 648103		619122 619123		BK069 619122	Turbo-trashboard R
				BK069 619123	Turbo-trashboard L
612108 612109		619120 619121		BK071 612108	Mouldboard R H4
				BK071 612109	Mouldboard L H4
				BK077 619120	Shin R H4
				BK077 619121	Shin L H4
				BK071 612110	Mouldboard R H6
				BK071 612111	Mouldboard L H6
				BK077 619128	Shin R H6
				BK077 619129	Shin L H6
				BK084 648102	Mouldboard extension R
				BK084 648103	Mouldboard extension L

#### Shares, points and accessories

622200 (622166) 622201 (622167)		622180 622181		622128 622129		622174 622175		MOL180C MOL181C	BK113 622200	EUROSHARE 14" H
									BK113 622201	EUROSHARE 14" V
									BK113 622202	EUROSHARE 16" H
									BK113 622203	EUROSHARE 16" V
									BK113 622204	EUROSHARE 18" R
622202 (622172) 622203 (622173)		MOL203C MOL202C							BK113 622205	EUROSHARE 18" L
									BK095 622128	EUROPOINT Z- R
									BK095 622129	EUROPOINT Z- L
									BK095 622174	EUROPOINT Z-reinforc. R
									BK095 622175	EUROPOINT Z-reinforc. L
									BK095 622180	EUROPOINT rev. R
									BK095 622181	EUROPOINT rev. L
622204 622205		MOL202 MOL203							BK095 MOL180C	EUROCARBIDE M3 point R
									BK095 MOL181C	EUROCARBIDE M3 point L
									BK165 MOL202C	EUROCARBIDESHARE M516" R
									BK165 MOL203C	EUROCARBIDESHARE M5 16" L
									BK165 MOL202	EUROSHARE M5 16" R
									BK165 MOL203	EUROSHARE M5 16" L
									BK166 MOL25-0	M7- Adapter R
									BK166 MOL25-1	M7- Adapter L
									MOL83	M7 point rev. R/L
									4979058	Wedge for M7 point
									BK096 270MOL	Share knife R
									BK096 271MOL	Share knife L

**For KUHN-HUARD Euroshares, please use landsidepoint 223120/223121 and 223120MOL/223121MOL.**

#### Landsides

223122		223120 223121		BK097 223120	Skim point R
				BK097 223121	Skim point L
279140		223120MOL 223121MOL		BK097 223120MOL	Skim point R
				BK097 223121MOL	Skim point L
				BK099 223122	Landside, rev. R&L
				BK099 279140	Landside, rev. R&L

#### Parts to mount on landsides

63600A		1349408 1349409		BK094 63600A	Wearing plate, rev. R&L
				BK094 63601A	Wearing plate, rev. R&L
				BK052 1349408	Sword coulter R
				BK052 1349409	Sword coulter L
				BK096 800MOL	Subsoiler blade R
				BK096 801MOL	Subsoiler blade L





Parts to fit:

## KUHN HB4 and HB6 ploughbodies

### Bolt box no. Article-no. Designation

#### Shins and accessories

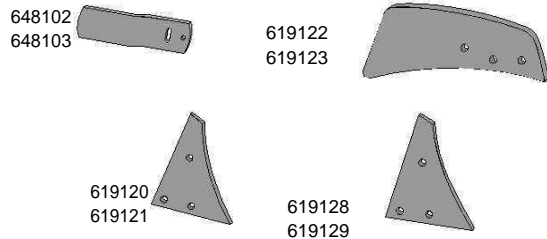

BK069	619122	Turbo-trashboard R
BK069	619123	Turbo-trashboard L
BK077	619120	Mouldboard R H6
BK077	619121	Mouldboard L H6
BK077	619128	Shin R H6
BK077	619129	Shin L H6
BK084	648102	Mouldboard extension R
BK084	648103	Mouldboard extension L

#### Shares, points and accessories

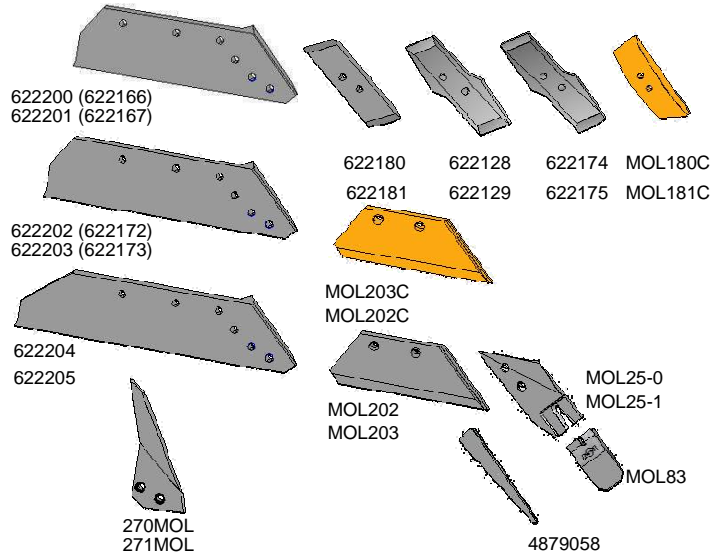

BK113	622200	EUROSHARE 14" H
BK113	622201	EUROSHARE 14" V
BK113	622202	EUROSHARE 16" H
BK113	622203	EUROSHARE 16" V
BK113	622204	EUROSHARE 18" R
BK113	622205	EUROSHARE 18" L
BK095	622128	EUROPOINT Z- R
BK095	622129	EUROPOINT Z- L
BK095	622174	EUROPOINT Z-reinforc. R
BK095	622175	EUROPOINT Z-reinforc. L
BK095	622180	EUROPOINT rev. R
BK095	622181	EUROPOINT rev. L
BK095	MOL180C	EUROCARBIDE M3 point R
BK095	MOL181C	EUROCARBIDE M3 point L
BK165	MOL202C	EUROCARBIDESHARE M516" R
BK165	MOL203C	EUROCARBIDESHARE M5 16" L
BK165	MOL202	EUROSHARE M5 16" R
BK165	MOL203	EUROSHARE M5 16" L
BK166	MOL25-0	M7- Adapter R
BK166	MOL25-1	M7-Adapter L
	MOL83	M7 point rev. R/L
	4979058	Wedge for M7 point
BK096	270MOL	Share knife R
BK096	271MOL	Share knife L

For KUHN-HUARD Euroshares, please use landsidepoint 223120/223121 and 223120MOL/223121MOL.

#### Landsides

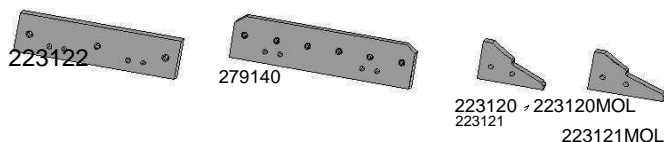

BK097	223120	Skim point R
BK097	223121	Skim point L
BK097	223120MOL	Skim point R
BK097	223121MOL	Skim point L
BK099	223122	Landside, rev. R&L
BK099	279140	Landside, rev. R&L

#### Parts to mount on landsides

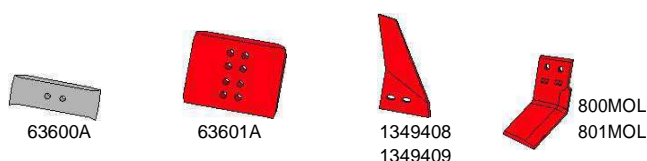

BK094	63600A	Wearing plate, rev. R&L
BK094	63601A	Wearing plate, rev. R&L
BK052	1349408	Sword coulter R
BK052	1349409	Sword coulter L
BK096	800MOL	Subsoiler blade R
BK096	801MOL	Subsoiler blade L



Parts to fit:

# KUHN SK ploughbody

	<u>Bolt box no.</u>	<u>Article-no.</u>	<u>Designation</u>
<b>Mouldboard and shin</b>			
<p>616242 616243</p> <p>619278 619279</p>	BK071	616242	Mouldboard R
	BK071	616243	Mouldboard L
	BK150	619278	Shin R
	BK150	619279	Shin L
<b>Shares, points and accessories</b>			
<p>622328 622329</p> <p>622180 622181</p> <p>622128 622129</p> <p>622174 622175</p> <p>MOL180C MOL181C</p> <p>622330 (H0401860) 622331 (H0401870)</p> <p>MOL203C MOL202C</p> <p>MOL300C MOL301C</p> <p>MOL202 MOL203</p> <p>MOL30-0 MOL30-1</p> <p>MOL83</p> <p>270MOL 271MOL</p> <p>4879058</p>	BK095	622180	EUROPOINT rev. R
	BK095	622181	EUROPOINT rev. L
	BK095	MOL180C	EUROCARBIDE M3 point R
	BK095	MOL181C	EUROCARBIDE M3 point L
	BK095	622128	EUROPOINT Z- R
	BK095	622129	EUROPOINT Z- L
	BK095	622174	EUROPOINT Z- reforc. R
	BK095	622175	EUROPOINT Z- reforc. L
	BK113	622328	Share f/rev. point 14" R
	BK113	622329	Share f/rev. point 14" L
	BK113	622330	Share f/rev. point 16" R
	BK113	622331	Share f/rev. point 16" L
	BK165	MOL202C	EUROCARBIDESHARE M516" R
	BK165	MOL203C	EUROCARBIDESHARE M5 16" L
	BK165	MOL202	EUROSHARE M5 16" R
	BK165	MOL203	EUROSHARE M5 16" L
	BK166	MOL30-0	M7- Adapter R
	BK166	MOL30-1	M7-Adapter L
		MOL83	M7 point rev. R/L
		4879058	Wedge for M7 point
BK166	MOL300C	EUROCARBIDE M5 point R	
BK166	MOL301C	EUROCARBIDE M5 point L	
BK096	270MOL	Share knife R	
BK096	271MOL	Share knife L	
<b>For KUHN-HUARD Euroshares, please use landsidepoint MOL761216 / MOL761217.</b>			
<b>Landsides</b>			
<p>279140</p> <p>MOL761216 MOL761217</p> <p>223122</p>	BK099	279140	Landside, rev. R&L
	BK097	MOL761216	Skim point R
	BK097	MOL761217	Skim point L
	BK099	223122	Landside, rev. R&L
<b>Parts to mount on landsides</b>			
<p>63600A</p> <p>63601A</p> <p>1349408 1349409</p> <p>800MOL 801MOL</p>	BK094	63600A	Wearing plate, rev. R&L
	BK094	63601A	Wearing plate, rev. R&L
	BK052	1349408	Sword coulter R
	BK052	1349409	Sword coulter L
	BK096	800MOL	Subsoiler blade R
	BK096	801MOL	Subsoiler blade L

Parts to fit:

# KUHN VL ploughbody

**Bolt box no. Article-no. Designation**

**Shin**

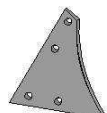

H0403520  
H0403530

BK150	H0403520	Shin R
BK150	H0403530	Shin L

**Shares, points and accessories**

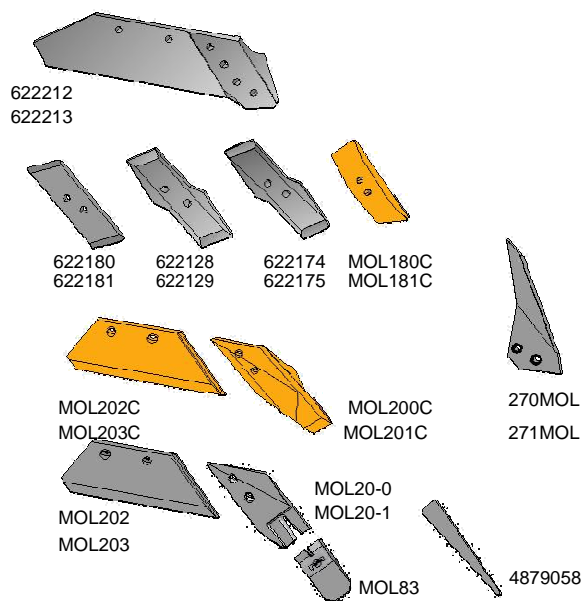

BK095	622180	EUROPOINT rev. R
BK095	622181	EUROPOINT rev. L
BK095	MOL180C	EUROCARBIDE M3 point R
BK095	MOL181C	EUROCARBIDE M3 point L
BK095	622128	EUROPOINT Z- R
BK095	622129	EUROPOINT Z- L
BK095	622174	EUROPOINT Z- reforc. R
BK095	622175	EUROPOINT Z- reforc. L
BK166	MOL200C	EUROCARBIDE M5 point R
BK166	MOL201C	EUROCARBIDE M5 point L
BK113	622213	Share f/rev. point 16" R
BK113	622212	Share f/rev. point 16" L
BK165	MOL202C	EUROCARBIDESHARE M5 16" R
BK165	MOL203C	EUROCARBIDESHARE M5 16" L
BK165	MOL202	EUROSHARE M5 16" R
BK165	MOL203	EUROSHARE M5 16" L
BK166	MOL20-0	M7-Adpter R
BK166	MOL20-1	M7-Adpter R
	MOL83	M7 point rev. R/L
	4879058	Wegde for M7 point
BK096	270MOL	Share knife R
BK096	271MOL	Share knife L

**Landsides**

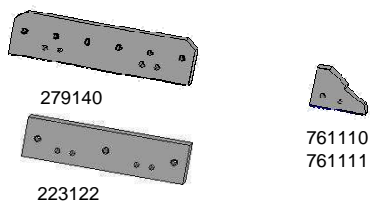

BK099	279140	Landside, rev. R&L
BK099	223122	Landside, rev. R&L
BK098	761110	Skim point R
BK098	761111	Skim point L

**Parts to mount on landsides**

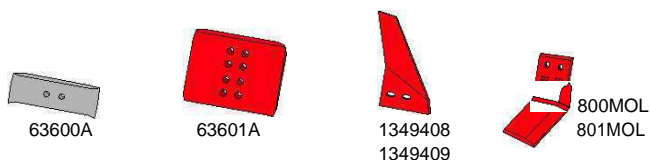

BK094	63600A	Wearing plate, rev. R&L
BK094	63601A	Wearing plate, rev. R&L
BK052	1349408	Sword coulter R
BK052	1349409	Sword coulter L
BK096	800MOL	Subsoiler blade R
BK096	801MOL	Subsoiler blade L



Parts to fit:

## KUHN VS/N ploughbodies

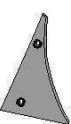
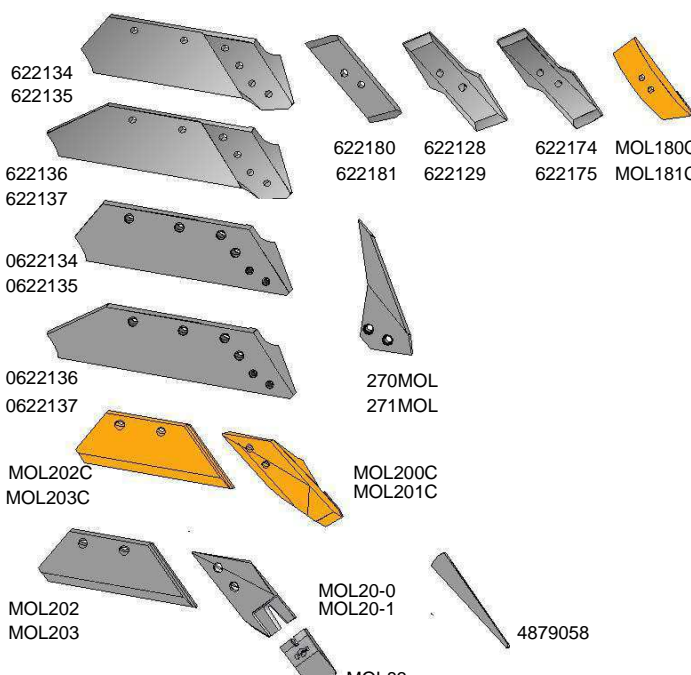

### Bolt box no. Article-no. Designation

Shin				
 619200 619201		BK052	619200	Shin R
		BK052	619201	Shin L
Shares, points and accessories				
 622134 622135 622136 622137 0622134 0622135 0622136 0622137 MOL202C MOL203C MOL202 MOL203 MOL200C MOL201C MOL20-0 MOL20-1 MOL83 4879058 270MOL 271MOL	622180	BK095	622180	EUROPOINT rev. R
	622128	BK095	622181	EUROPOINT rev. L
	622174	BK095	MOL180C	EUROCARBIDE M3 point R
	MOL180C	BK095	MOL181C	EUROCARBIDE M3 point L
	622129	BK095	622128	EUROPOINT Z- R
	622129	BK095	622129	EUROPOINT Z- L
	622174	BK095	622174	EUROPOINT Z- reforc. R
	622175	BK095	622175	EUROPOINT Z- reforc. L
	622175	BK166	MOL200C	EUROCARBIDE M5 point R
	622175	BK166	MOL201C	EUROCARBIDE M5 point L
	622134	BK113	622134	Share f/rev. point 14" R
	622135	BK113	622135	Share f/rev. point 14" L
	622136	BK113	622136	Share f/rev. point 16" R
	622137	BK113	622137	Share f/rev. point 16" L
	0622134	BK113	0622134	Share f/rev. point 14" R
	0622135	BK113	0622135	Share f/rev. point 14" L
	0622136	BK113	0622136	Share f/rev. point 16" R
	0622137	BK113	0622137	Share f/rev. point 16" L
	MOL202C	BK165	MOL202C	EUROCARBIDESHARE M5 16" R
	MOL203C	BK165	MOL203C	EUROCARBIDESHARE M5 16" L
MOL202	BK165	MOL202	EUROSHARE M5 16" R	
MOL203	BK165	MOL203	EUROSHARE M5 16" L	
MOL20-0	BK166	MOL20-0	M7-Adpater R	
MOL20-1	BK166	MOL20-1	M7-Adpater R	
MOL83		MOL83	M7 point rev. R/L	
4879058		4879058	Wegde for M7 point	
270MOL	BK096	270MOL	Share knife R	
271MOL	BK096	271MOL	Share knife L	
Landside				
278074	BK077	278074	Landside, short R	
278075	BK077	278075	Landside, short L	
278076	BK072	278076	Landside, long R	
278077	BK072	278077	Landside, long L	

Parts to fit:

## KUHN ploughs

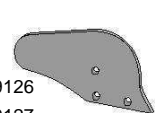
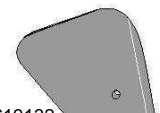
### Skim shares and skim mouldboards

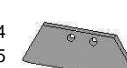
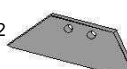
 619126 619127	631100	BK058	619126	Skim mouldboard R
	631101	BK058	619127	Skim mouldboard L
 619132 619133	631104	BK058	619132	Skim mouldboard R
	631105	BK058	619133	Skim mouldboard L
 631102 631103	631100	BK052	631100	Skim share R
	631101	BK052	631101	Skim share L
 631104 631105	631102	BK052	631102	Skim share R
	631103	BK052	631103	Skim share L
 631112	631104	BK052	631104	Skim share R
	631105	BK052	631105	Skim share L
	631112	BK052	631112	Skim share R&L

Parts to fit:

## KVERNELAND ploughbody no. 3

### Bolt box no. Article-no. Designation

#### Mouldboards, shins and accessories

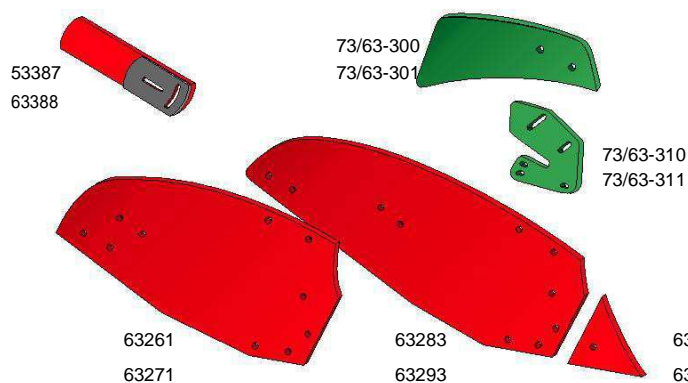

BK167	73/63-300	Turbo-trashboard R
BK167	73/63-301	Turbo-trashboard L
	73/63-310	Fittings for trashboard R
	73/63-311	Fittings for trashboard L
BK082	53387	Mouldboard extension R
BK082	63388	Mouldboard extension L
Bk056	63283	Mouldboard R
BK056	63293	Mouldboard L
BK056	63261	Mouldboard R
BK056	63271	Mouldboard L
	63240	Shin R
	63250	Shin L

#### Shares, points and accessories

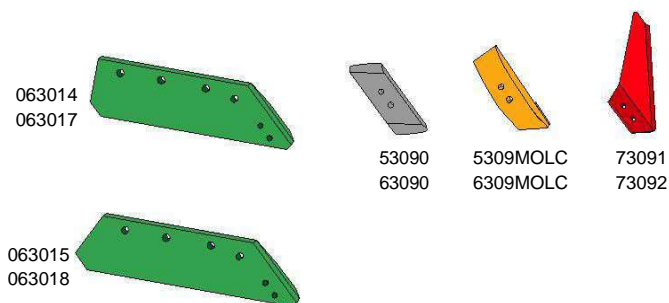

BK100	063014	EUROSHARE 14" R
BK100	063017	EUROSHARE 14" L
BK100	063015	EUROSHARE 16" R
BK100	063018	EUROSHARE 16" L
BK096	73091	Share knife R
BK096	73092	Share knife L
BK094	53090	EUROPOINT Rev. R
BK094	63090	EUROPOINT Rev. L
BK095	5309MOLC	EUROCARBIDE M3 point R
BK095	6309MOLC	EUROCARBIDE M3 point L

#### Landsides

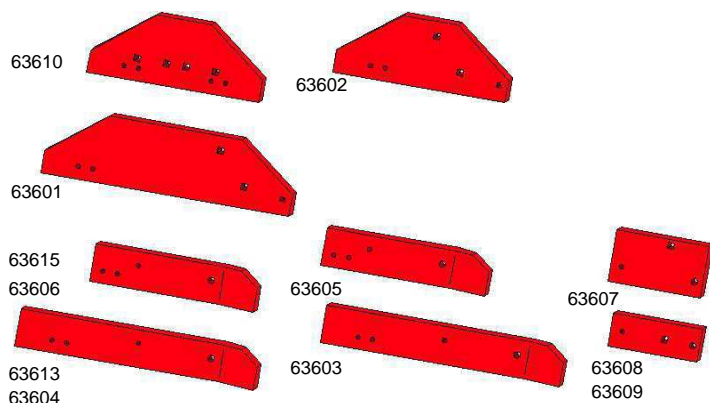

BK128	63610	Landside, short R&L
BK103	63615	Landside, short, low R
BK103	63606	Landside, short, low L
BK103	63613	Landside, long, low R
BK103	63604	Landside, long, low L
BK118	63602	Landside, short R
BK118	63601	Landside, long R
BK103	63605	Landside, short, low R
BK103	63603	Landside, long, low R
BK136	63607	Conversion plate R
	63608	Conversion plate f/rev.plough R
	63609	Conversion plate f/rev.plough L

#### Parts to mount on landsides

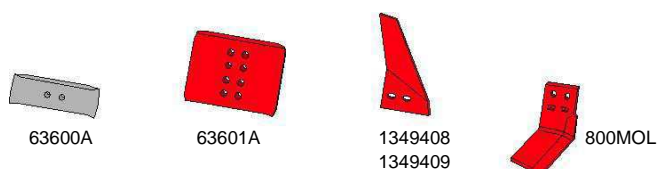

BK094	63600A	Wearing plate, rev. R&L
BK094	63601A	Wearing plate, rev. R&L
BK052	1349408	Sword coulter R
BK052	1349409	Sword coulter L
BK096	800MOL	Subsoiler blade R
BK096	801MOL	Subsoiler blade L

Parts to fit:

## KVERNELAND ploughbodies no. 6, 7, 8, 9 and 28

Mouldboards, shins and accessories		Bolt box no.	Article-no.	Designation
		BK167	73/63-300	Turbo-trashboard R
		BK167	73/63-301	Turbo-trashboard L
			73/63-310	Fittings for trashboard R
			73/63-311	Fittings for trashboard L
		BK156	073801	Brace R&L (for frog 73406/7)
		BK156	73803	Brace R&L (for frog 73411/12)
		BK156	073831	Brace R&L (for frog 73406/7)
		BK156	083810	Brace R&L (for frog 73406/7)
		BK113	73800	Brace fitting R
		BK113	73801	Brace fitting L
		BK082	53387	Mouldboard extension R
		BK082	63388	Mouldboard extension L
		BK059	73290	Mouldboard R
		BK059	73291	Mouldboard L
		BK056	73286	Mouldboard R
		BK056	73287	Mouldboard L
		BK056	73280	Mouldboard R
		BK056	73281	Mouldboard L
		BK154	83228	Mouldboard R
		BK154	83229	Mouldboard L
		BK058	73256	Shin R
		BK058	73257	Shin L
		BK052	73250	Shin R
		BK052	73251	Shin L
			73266	Bracket for shin R
			73267	Bracket for shin L
			73411	Frog R
			73412	Frog L
		73406	Frog R	
		73407	Frog L	
Shares, points and accessories		Bolt box no.	Article-no.	Designation
		BK113	073002	EUROSHARE 14" R
		BK113	073003	EUROSHARE 14" L
		BK113	073004	EUROSHARE 16" R
		BK113	073005	EUROSHARE 16" L
		BK114	073006	EUROSHARE 18" R
		BK114	073007	EUROSHARE 18" L
		BK114	073008	EUROSHARE 20" R
		BK114	073009	EUROSHARE 20" L
		BK170	83018	EUROSHARE M5 16" R
		BK170	83019	EUROSHARE M5 16" L
		BK170	83020	EUROSHARE M5 18" R
		BK170	83021	EUROSHARE M5 18" L
		BK170	83022	EUROSHARE M5 20" R
		BK170	83023	EUROSHARE M5 20" L
		BK111	83010C	EUROCARBIDE M5 point R
		BK111	83011C	EUROCARBIDE M5 point L
		BK111	MOL83-0	M7-adapter R
		BK111	MOL83-1	M7-adapter L
			MOL83	M7 point rev. R/L
			4879058	Wegde for M7 point
		BK095	73091	Share knife R
		BK095	73092	Share knife L
	BK094	53090	EUROPOINT Rev. R	
	BK094	63090	EUROPOINT Rev. L	
	BK095	5309MOLC	EUROCARBIDE M3 point R	
	BK095	6309MOLC	EUROCARBIDE M3 point L	
		73414	Bracket for 18" and 20" shares R	
		73415	Bracket for 18" and 20" shares L	
	BK170	MOL83018C	EUROCARBIDESHARE M5 16" R	
	BK170	MOL83019C	EUROCARBIDESHARE M5 16" L	

**Did you know...**





that you can wear out more than six points before you have to replace the M7-adapter?

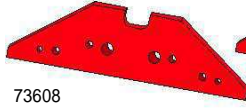
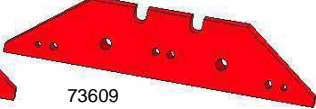
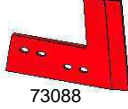
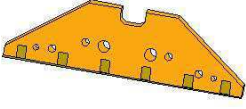
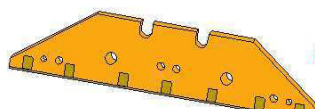

Parts to fit:

## KVERNELAND ploughbodies no. 6, 7, 8, 9 and 28

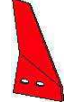
Landsides and share knives		Bolt box no.	Article-no.	Designation
	73608	BK111	73608	Landside, short R&L
	73609	BK111	73609	Landside, long R&L
	73088	BK110	73088	Share knife R
		BK110	73089	Share knife L
		BK110	84320	Share knife R
		BK110	84321	Share knife L
	73608C	BK111	73608C	Landside, coated short R&L
	73609C	BK111	73609C	Landside, coated long R&L
			84320	
			84321	

Parts to mount on landsides			Article-no.	Designation
	63600A	BK094	63600A	Wearing plate, rev. R&L
	63601A	BK094	63601A	Wearing plate, rev. R&L
	1349408	BK052	1349408	Sword coulter R
	1349409	BK052	1349409	Sword coulter L
	800MOL	BK096	800MOL	Subsoiler blade R
	801MOL	BK096	801MOL	Subsoiler blade L

### Did you know...

that Mølbro's landsides are longer than original landsides. This feature gives your plough much more stability while ploughing, which makes it easier to control the plough.

### Did you know...

that the upset forged front gives extra support for mounting of the reversible point or EUROPOINT and is designed to ensure that it is easy to get the plough into the soil.

Parts to fit:

## KVERNELAND ploughbodies no. 12 and 19

### Bolt box no. Article-no. Designation

#### Mouldboards, shins and accessories

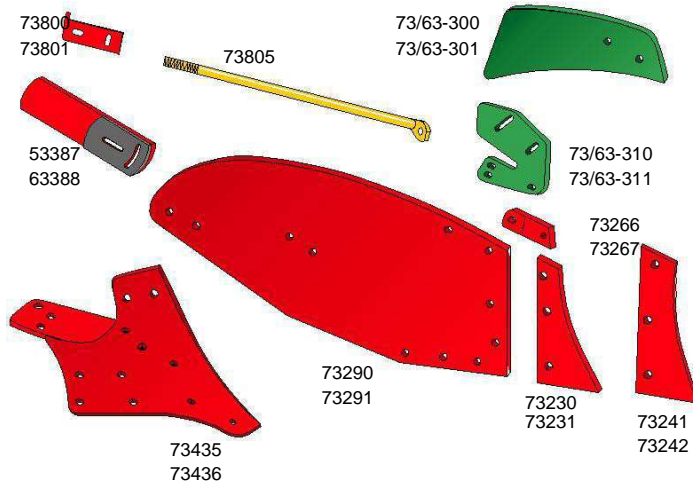

BK167	73/63-300	Turbo-trashboard R
BK167	73/63-301	Turbo-trashboard L
	73/63-310 73/63-311	Fittings for trashboard R
		Fittings for trashboard L
BK082	53387	Mouldboard extension R
BK082	63388	Mouldboard extension L
BK059	73290	Mouldboard R
BK059	73291	Mouldboard L
BK113	73800	Brace fitting R
BK113	73801	Brace fitting L
BK156	73805	Brace R&L (for frog)
BK058	73230	73406/7) Shin R
BK058	73231	Shin L
BK058	73241	Shin R
BK058	73242	Shin L
	73266	Bracket for shin R
	73267	R Bracket for shin L
	73435	Frog R
	73436	Frog L

#### Shares, points and accessories

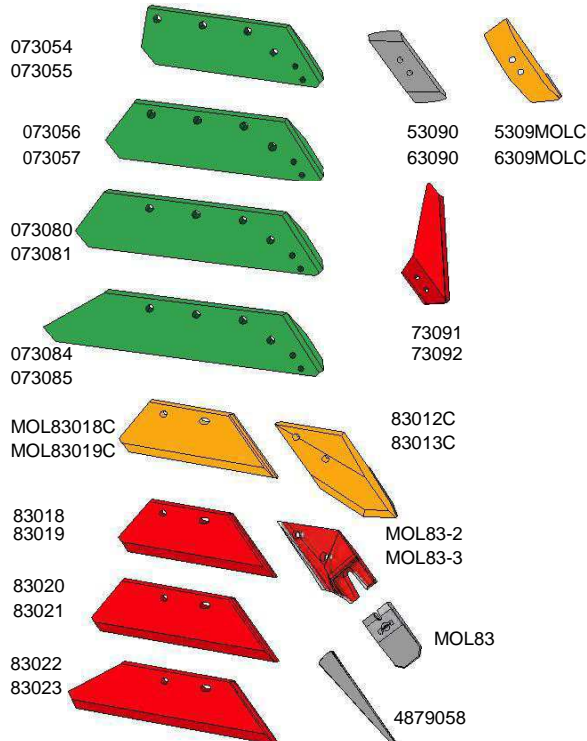



BK113	073054	EUROSHARE 14" R
BK113	073055	EUROSHARE 14" L
BK113	073056	EUROSHARE 16" R
BK113	073057	EUROSHARE 16" L
BK113	073080	EUROSHARE 18" R
BK113	073081	EUROSHARE 18" L
BK113	073084	EUROSHARE 20" R
BK113	073085	EUROSHARE 20" L
BK096	73091	Share knife R
BK096	73092	Share knife L
BK094	53090	EUROPOINT Rev. R
BK094	63090	EUROPOINT Rev. L
BK095	5309MOLC	EUROCARBIDE M3 point R
BK095	6309MOLC	EUROCARBIDE M3 point L
BK170	83018	EUROSHARE M5 16" R
BK170	83019	EUROSHARE M5 16" L
BK170	83020	EUROSHARE M5 18" R
BK170	83021	EUROSHARE M5 18" L
BK170	83022	EUROSHARE M5 20" R
BK170	83023	EUROSHARE M5 20" L
BK111	83012C	EUROCARBIDE M5 point R
BK111	83013C	EUROCARBIDE M5 point L
BK111	MOL83-2	M7-adapter R
BK111	MOL83-3	M7-adapter L
	MOL83	M7 point rev. R/L
	4879058	Wedge for M7 point
BK170	MOL83018C	EUROCARBIDESHARE M5 16" R
BK170	MOL83019C	EUROCARBIDESHARE M5 16" L



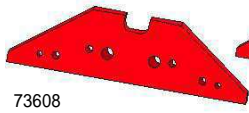
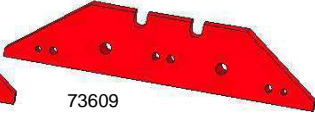
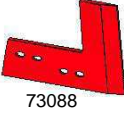
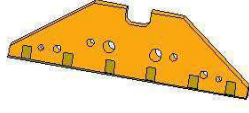
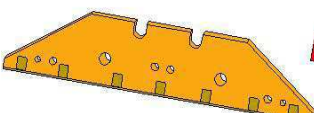

### Did you know...

that the special hole outline makes it possible to mount the point with a unique high headed bolt which allow the point to be worn even thinner?

Parts to fit:

## KVERNELAND ploughbodies no. 12 and 19

		<u>Bolt box no.</u>	<u>Article-no.</u>	<u>Designation</u>
<b>Landsides and share knives</b>				
			BK111 73608 BK111 73609 BK110 73088 Bk110 73089 BK110 84320 BK110 84321	Landside, short R&L Landside, long R&L Share knife R Share knife L Share knife R Share knife L
73608	73609	73088 73089		
			BK111 73608C BK111 73609C	Landside, coated short R&L Landside, coated long R&L
73608C	73609C	84320 84321		

<b>Parts to mount on landsides</b>				
				BK094 63600A BK094 63601A BK052 1349408 BK052 1349409 BK096 800MOL BK096 801MOL
63600A	63601A	1349408 1349409	800MOL 801MOL	Wearing plate, rev. R&L Wearing plate, rev. R&L Sword coulter R Sword coulter L Subsoiler blade R Subsoiler blade L

### Did you know...

that, if you use Mølbro's sword coulter 13494009/8 on the last furrow, you will not have problems with tire damages by stones if you are ploughing with wide tires?



Parts to fit:

## KVERNELAND ploughbodies no. 20 and 30

**Bolt box no. Article-no. Designation**

### Accessories

73/63-300  
73/63-301



BK167 73/63-300 Turbo-trashboard R  
BK167 73/63-301 Turbo-trashboard L



73/63-310  
73/63-311

73/63-310 Fittings for trashboard R  
73/63-311 Fittings for trashboard L

### Shares, point and accessories

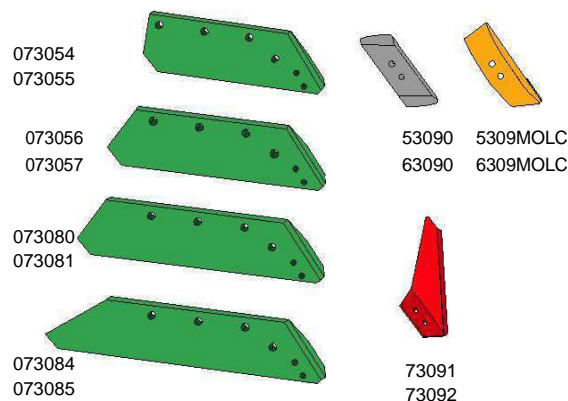

073054  
073055

073056  
073057

073080  
073081

073084  
073085

53090 5309MOLC  
63090 6309MOLC

73091  
73092

BK113 073054 EUROSHARE 14" R  
BK113 073055 EUROSHARE 14" L  
BK113 073056 EUROSHARE 16" R  
BK113 073057 EUROSHARE 16" L  
BK113 073080 EUROSHARE 18" R  
BK113 073081 EUROSHARE 18" L  
BK113 073084 EUROSHARE 20" R  
BK113 073085 EUROSHARE 20" L  
BK095 73091 Share knife R  
BK095 73092 Share knife L  
BK094 53090 EUROPOINT Rev. R  
BK094 63090 EUROPOINT Rev. L  
BK095 5309MOLC EUROCARBIDE M3 point R  
BK095 6309MOLC EUROCARBIDE M3 point L

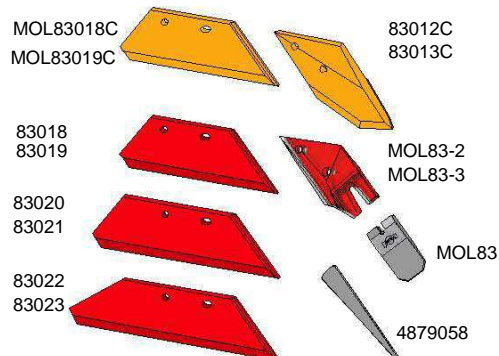

MOL83018C  
MOL83019C

83018  
83019

83020  
83021

83022  
83023

83012C  
83013C

MOL83-2  
MOL83-3

MOL83

4879058



BK170 83018 EUROSHARE M5 16" R  
BK170 83019 EUROSHARE M5 16" L  
BK170 83020 EUROSHARE M5 18" R  
BK170 83021 EUROSHARE M5 18" L  
BK170 83022 EUROSHARE M5 20" R  
BK170 83023 EUROSHARE M5 20" L  
BK111 83012C EUROCARBIDE M5 point R  
BK111 83013C EUROCARBIDE M5 point L  
BK111 MOL83-2 M7-adaptor R  
BK111 MOL83-3 M7-adaptor L  
MOL83 M7 point rev. R/L  
4879058 Wegde for M7 point  
BK170 MOL83018C EUROCARBIDESHARE M5 16" R  
BK170 MOL83019C EUROCARBIDESHARE M5 16" L



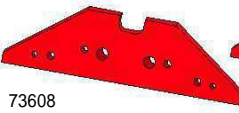
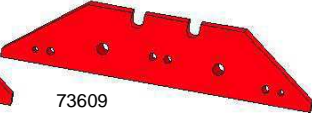
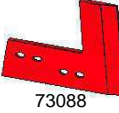
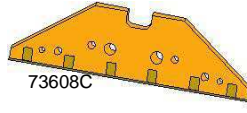
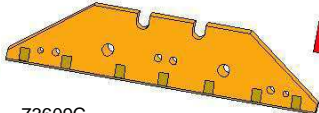

### Did you know...

that you will reduce mounting time by using Mølbros M5 system, because the carbide coated EUROCARBID M5 - point will last just as long as the share.

Parts to fit:





## KVERNELAND ploughbodies no. 20 and 30

		<u>Bolt box no.</u>	<u>Article-no.</u>	<u>Designation</u>
<b>Landsides and share knives</b>				
			<i>BK111</i> 73608	Landside, short R&L
73608	73609	73088 73089	<i>BK111</i> 73609	Landside, long R&L
			<i>BK110</i> 73088	Share knife R
73608C	73609C	84320 84321	<i>BK110</i> 73089	Share knife L
			<i>BK110</i> 84320	Share knife R
			<i>BK110</i> 84321	Share knife L
			<i>BK111</i> 73608C	Landside, coated short R&L
			<i>BK111</i> 73609C	Landside, coated long R&L

<b>Parts to mount on landsides</b>					
				<i>BK094</i> 63600A	Wearing plate, rev. R&L
63600A	63601A	1349408 1349409	800MOL 801MOL	<i>BK094</i> 63601A	Wearing plate, rev. R&L
				<i>BK052</i> 1349408	Sword coulter R
				<i>BK052</i> 1349409	Sword coulter L
				<i>BK096</i> 800MOL	Subsoiler blade R
				<i>BK096</i> 801MOL	Subsoiler blade L

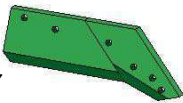
Parts to fit:

## KVERNELAND ploughbody serie 53

<b>Shares, point and accessories</b>					
				<i>BK095</i> 73091	Share knife R
53087	53090	5309MOLC	73091	<i>BK094</i> 53090	EUROPOINT rev. R
				<i>BK095</i> 5309MOLC	EUROCARBIDE M3 point R
				<i>BK100</i> 53087	EUROSHARE f/rev.point 14" R
				<i>BK100</i> 53088	EUROSHARE f/rev.point 16" R
53088					

<b>Landsides</b>					
				<i>BK118</i> 53684	Landside, short R
53684					

<b>Parts to mount on landsides</b>					
				<i>BK094</i> 63600A	Wearing plate, rev. R&L
63600A	63601A	1349408	800MOL	<i>BK094</i> 63601A	Wearing plate, rev. R&L
				<i>BK052</i> 1349408	Sword coulter R
				<i>BK096</i> 800MOL	Subsoiler blade R

Parts to fit:

# KVERNELAND ploughbody ECOMAT

**Bolt box no. Article-no. Designation**

**Shares, point and accessories**

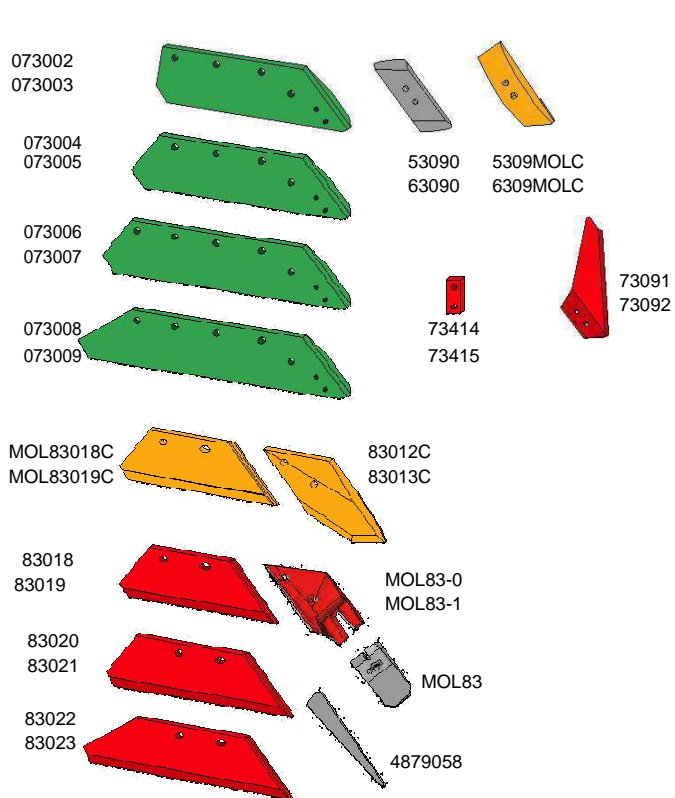

BK113	073002	EUROSHARE 14" R
BK113	073003	EUROSHARE 14" L
BK113	073004	EUROSHARE 16" R
BK113	073005	EUROSHARE 16" L
BK114	073006	EUROSHARE 18" R
BK114	073007	EUROSHARE 18" L
BK114	073008	EUROSHARE 20" R
BK114	073009	EUROSHARE 20" L
BK170	83018	EUROSHARE M5 16" R
BK170	83019	EUROSHARE M5 16" L
BK170	83020	EUROSHARE M5 18" R
BK170	83021	EUROSHARE M5 18" L
BK170	83022	EUROSHARE M5 20" R
BK170	83023	EUROSHARE M5 20" L
BK111	83010C	EUROCARBIDE M5 point R
BK111	83011C	EUROCARBIDE M5 point L
BK111	MOL83-0	M7-adapter R
BK111	MOL83-1	M7-adapter L
	MOL83	M7 point rev. R/L
	4879058	Wegde for M7 point
BK095	73091	Share knife R
BK095	73092	Share knife L
BK094	53090	EUROPOINT Rev. R
BK094	63090	EUROPOINT Rev. L
BK095	5309MOLC	EUROCARBIDE M3 point R
BK095	6309MOLC	EUROCARBIDE M3 point L
	73414	Bracket for 18" and 20" shares R
	73415	Bracket for 18" and 20" shares L
BK170	MOL83018C	EUROCARBIDESHARE M5 16" R
BK170	MOL83019C	EUROCARBIDESHARE M5 16" L

**Landsides and share knives**

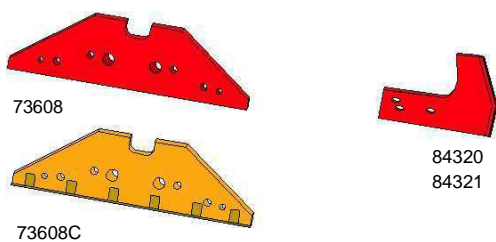

BK111	73608	Landside, short R&L
BK111	73608C	Landside, coated short R&L
BK110	84320	Share knife R
BK110	84321	Share knife L

**Parts to mount on landsides**

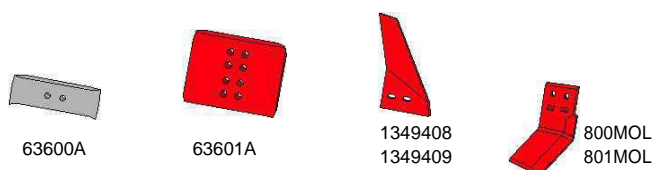

BK094	63600A	Wearing plate, rev. R&L
BK094	63601A	Wearing plate, rev. R&L
BK052	1349408	Sword coulter R
BK052	1349409	Sword coulter L
BK096	800MOL	Subsoiler blade R
BK096	801MOL	Subsoiler blade L

Parts to fit:

# KVERNELAND ploughs

**Bolt box no. Article-no. Designation**

**Skim shares, skim mouldboards and accesories**

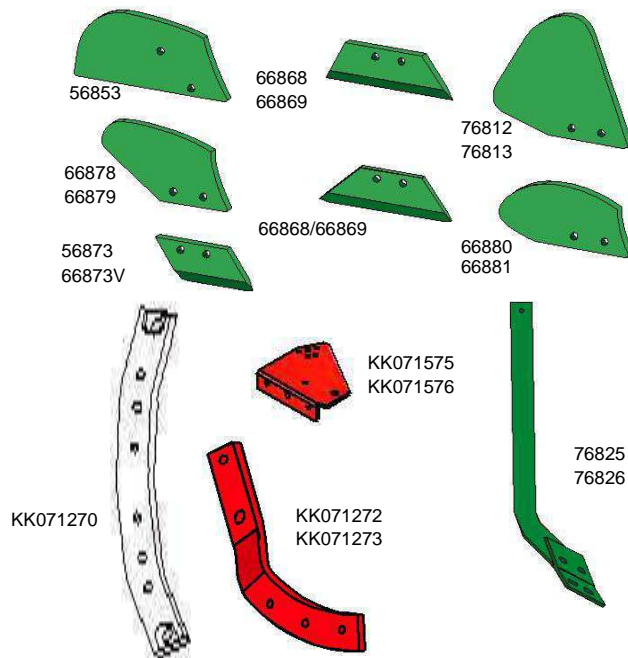

BK026	56853	Skim mouldboard R
BK026	66878	Skim mouldboard R
BK026	66879	Skim mouldboard L
BK026	76812	Skim mouldboard R
BK026	76813	Skim mouldboard L
BK026	66880	Skim mouldboard R
BK026	66881	Skim mouldboard L
BK004	56873	Skim share, short R
BK004	66873V	Skim share, short L
BK004	66868	Skim share, long R
BK004	66869	Skim share, long L
BK004	66868/ 66869	Skim share, R&L
	76825	Beam R 800mm
	76826	Beam L 800mm
	KK071575	Adapter plade beam buttom
	KK071576	Adapter plade beam top
	KK071270	Beam 800mm center
	KK071272	Beam R
	KK071273	Beam L

**Disc coulters and accessories**

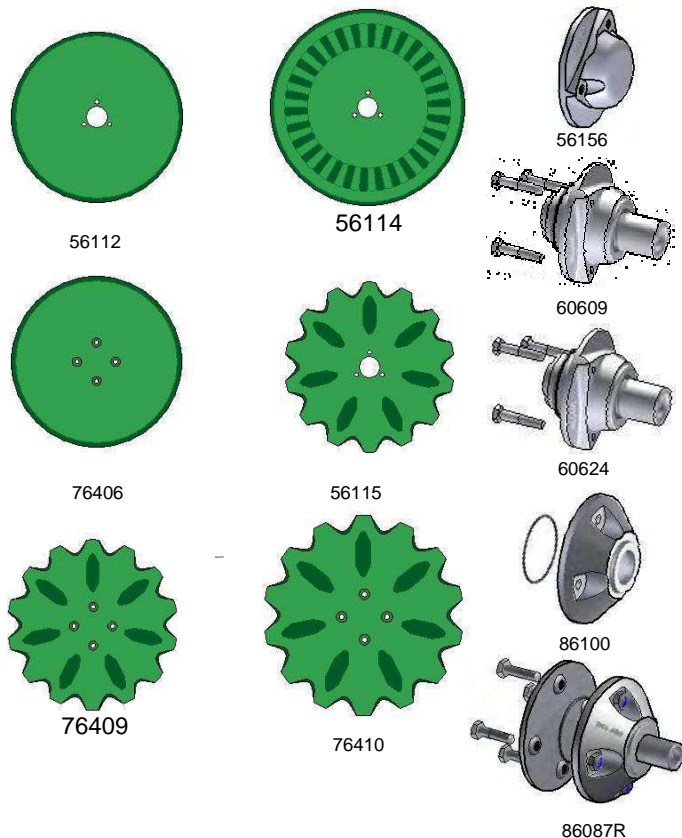

56112	Disc coulter, 18"
56114	Disc coulter, rippled 20"
56115	Disc coulter, notched 18"
76406	Disc coulter 18"
76409	Disc coulter 18"
76410	Disc coulter 20"
56156	Universal cover for hub
60609	Hub disc coulter Æ34mm
60624	Hub disc coulter Æ30mm
86100	Hub for disc coulter



Parts to fit:

# LEMKEN B ploughbody

	<b>Bolt box no.</b>	<b>Article-no.</b>	<b>Designation</b>
<b>Mouldboards, shins and accessories</b>			
		3470860	Bk009 3470860 Turbo-trashboard R
		3470861	BK009 3470861 Turbo-trashboard L
		3476000	BK013 3476000 Mouldboard extension R
		3476001	BK013 3476001 Mouldboard extension L
		3441034	BK005 3441034 Mouldboard R
		3441035	BK005 3441035 Mouldboard L
		3441040	BK019 3441040 Mouldboard R
		3441041	BK019 3441041 Mouldboard L
		475MOLR	475MOLR Brace fitting R
		475MOLL	475MOLL Brace fitting L
		570MOL	570MOL Support for mouldboard
		3451000	BK007 3451000 Shin R
		3451001	BK007 3451001 Shin L
		3451002	BK007 3451002 Shin R (10mm)
		3451003	BK007 3451003 Shin L (10mm)
		3451010	BK010 3451010 Shin R (8mm)
		3451011	BK010 3451011 Shin L (8mm)
		4671002	BK140 4671002 Frog R
		4671003	BK140 4671003 Frog L
		4671010	BK140 4671010 Frog R
		4671011	BK140 4671011 Frog L
<b>Shares and points</b>			
		3365540	BK032 3365540 EUROPOINT rev. R
		3365541	Bk032 3365541 EUROPOINT rev. L
		3364050	BK036 3364050 EUROPOINT R
		3364051	BK036 3364051 EUROPOINT L
		3364150	BK036 3364150 EUROCARBIDE M5 point R
		3364151	BK036 3364151 EUROCARBIDE M5 point L
		3352010	BK036 3352010 EUROSHARE 14" R
		3352011	BK036 3352011 EUROSHARE 14" L
		3352020	BK036 3352020 EUROSHARE 16" R
		3352021	BK036 3352021 EUROSHARE 16" L
		3352030	BK036 3352030 EUROSHARE 18" R
		3352031	BK036 3352031 EUROSHARE 18" L
		3352130	BK036 3352130 EUROSHARE 18" R (11mm)
		3352131	BK036 3352131 EUROSHARE 18" L (11mm)
		MOL4150	BK036 MOL4150 M7-Adapter R
		MOL4151	BK036 MOL4151 M7-Adapter L
		MOL83	BK036 MOL83 M7 point
		4879058	4879058 Wedge for M7 point
		MOL2030C	BK038 MOL2030C EUROCARBIDE share 18" R
		MOL2031C	BK038 MOL2031C EUROCARBIDE share 18" L
		3352230	BK036 3352230 EUROCARBIDESHARE M5 18" R
		3352231	BK036 3352231 EUROCARBIDESHARE M5 18" L
<b>Landsides and share knives</b>			
		3401900AK10	BK008 3401900AK10 Landside, front R
		3492890	BK008 3492890 Share knife R
		3492891	BK008 3492891 Share knife L
		3411500	BK008 3411500 Landside, front L
		3411504	BK036 3411504 Landside, short R&L
		3411508	BK036 3411508 Landside, long R&L
		3401900AK10	Bk037 3411508 Landside, tall R&L
		3411460	BK037 3411460 Landside, tall R&L
		3492890	BK003 3492890 Share knife R
		3492891	BK003 3492891 Share knife L
<b>Parts to mount on landsides</b>			
		63600A	BK094 63600A Wearing plate, rev. R&L
		63601A	BK094 63601A Wearing plate, rev. R&L
		1349408	BK052 1349408 Sword coulter R
		1349409	BK052 1349409 Sword coulter L
		800MOL	BK096 800MOL Subsoiler blade R
		801MOL	BK096 801MOL Subsoiler blade L

Parts to fit:

# LEMKEN BS 40 ploughbody

**Bolt box no. Article-no. Designation**

## Mouldboards, shins and accessories

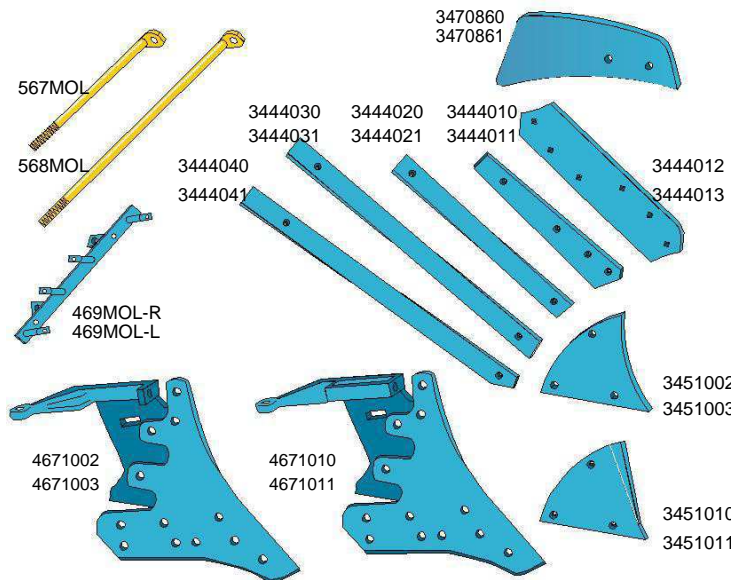

BK009	3470860	Turbo-trashboard R
BK009	3470861	Turbo-trashboard L
BK141	469MOL-R	Stay with support R
BK141	469MOL-L	Stay with support L
	567MOL	Support for stay, short
	568MOL	Support for stay, long
BK007	3451002	Shin R (10mm)
BK007	3451003	Shin L (10mm)
BK010	3451010	Shin R (8mm)
BK010	3451011	Shin L (8mm)
BK172	3444010	Mouldboard stripe R
BK172	3444011	Mouldboard stripe L
BK172	3444020	Mouldboard stripe R
BK172	3444021	Mouldboard stripe L
BK172	3444030	Mouldboard stripe R
BK172	3444031	Mouldboard stripe L
BK172	3444040	Mouldboard stripe R
BK172	3444041	Mouldboard stripe L
BK006	3444012	Rev. top stripe R
BK006	3444013	Rev. top stripe L
BK140	4671002	Frog R
BK140	4671003	Frog L
BK140	4671010	Frog R
BK140	4671011	Frog L

## Shares and points

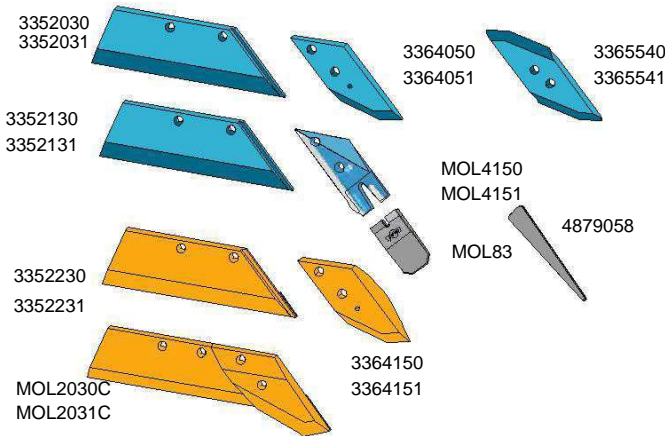

BK032	3365540	EUROPOINT rev. R
BK032	3365541	EUROPOINT rev. L
BK036	3364050	EUROPOINT R
BK036	3364051	EUROPOINT L
BK036	3364150	EUROCARBIDE M5 point R
BK036	3364151	EUROCARBIDE M5 point L
BK036	3352030	EUROSHARE 18" R
BK036	3352031	EUROSHARE 18" L
BK036	3352130	EUROSHARE 18" R (11mm)
BK036	3352131	EUROSHARE 18" L (11mm)
BK038	MOL2030C	EUROCARBIDE share 18" R
BK038	MOL2031C	EUROCARBIDE share 18" L
BK036	3352230	EUROCARBIDeshare M5 18" R
BK036	3352231	EUROCARBIDeshare M5 18" L
BK036	MOL4150	M7-Adapter R
BK036	MOL4151	M7-Adapter L
	MOL83	M7 point
	4879058	Wedge for M7 point

## Landsides and share knives

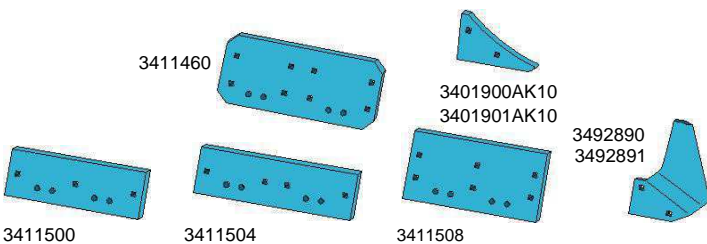

BK008	3401900AK10	Landside, front R
BK008	3401901AK10	Landside, front L
BK036	3411500	Landside, short R&L
BK036	3411504	Landside, long R&L
BK037	3411508	Landside, tall R&L
BK037	3411460	Landside, tall R&L
BK003	3492890	Share knife R
BK003	3492891	Share knife L

## Parts to mount on landsides

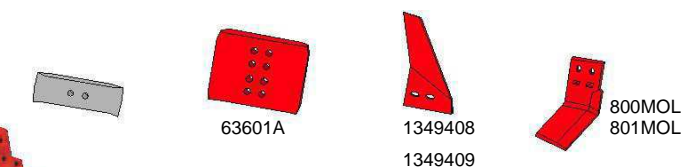

BK094	63600A	Wearing plate, rev. R&L
BK094	63601A	Wearing plate, rev. R&L
BK052	1349408	Sword coulter R
BK052	1349409	Sword coulter L
BK096	800MOL	Subsoiler blade R
BK096	801MOL	Subsoiler blade L



Parts to fit:

# LEMKEN BS 42 ploughbody

	<b>Bolt box no.</b>	<b>Article-no.</b>	<b>Designation</b>
<b>Mouldboards, shins and accessories</b>			
		567MOL	567MOL
		568MOL	568MOL
		3470860 3470861	BK009 3470860 Turbo-trashboard R BK009 3470861 Turbo-trashboard L
		469MOL-R 469MOL-L	BK141 469MOL-R Stay with support R BK141 469MOL-L Stay with support L
		4695600 4695601	4695600 Stay L 4695601 Stay L
		3444030 3444031 3444020 3444021 3444010 3444011	3444012 Mouldboard stripe R 3444013 Mouldboard stripe L
		3444042 3444043	3444042 Mouldboard stripe R 3444043 Mouldboard stripe L
		3451002 3451003	BK007 3451002 Shin R (10mm) BK007 3451003 Shin L (10mm)
		3451010 3451011	BK010 3451010 Shin R (8mm) BK010 3451011 Shin L (8mm)
		3451010 3451011	BK172 3444010 Mouldboard stripe R BK172 3444011 Mouldboard stripe L BK172 3444020 Mouldboard stripe R BK172 3444021 Mouldboard stripe L BK172 3444030 Mouldboard stripe R BK172 3444031 Mouldboard stripe L BK173 3444042 Mouldboard stripe R BK173 3444043 Mouldboard stripe L
		4671002 4671003	BK006 3444012 Rev. top stripe R BK006 3444013 Rev. top stripe L BK140 4671002 Frog R BK140 4671003 Frog L
		4671010 4671011	BK140 4671010 Frog R BK140 4671011 Frog L
<b>Shares and points</b>			
		3352034 3352035	Bk032 3365540 EUROPOINT rev. R BK032 3365541 EUROPOINT rev. L
		3352134 3352135	Bk036 3364050 EUROPOINT R BK036 3364051 EUROPOINT L
		3352234 3352235	BK036 3364150 EUROCARBIDE M5 point R BK036 3364151 EUROCARBIDE M5 point L
		3364050 3364051	
		MOL4150 MOL4151	BK037 3352034 EUROSARE 20" R BK037 3352035 EUROSARE 20" L
		MOL83	BK037 3352134 EUROSARE 20" R (11mm) BK037 3352135 EUROSARE 20" L (11mm)
		3364150 3364151	BK036 MOL4150 M7-Adapter R BK036 MOL4151 M7-Adapter L
		MOL2035C MOL2034C	MOL83 M7 point 4879058 Wedge for M7 point
		3364150 3364151	BK039 MOL2034C EUROCARBIDE share 20" R BK039 MOL2035C EUROCARBIDE share 20" L
		3352234 3352235	BK037 3352234 EUROCARBIDEshare M5 20" R BK037 3352235 EUROCARBIDEshare M5 20" L
<b>Landsides and share knives</b>			
		3411500 3411504 3411508	BK008 3401900AK10 Landside, front R BK008 3401901AK10 Landside, front L BK036 3411500 Landside, short R&L BK036 3411504 Landside, long R&L BK037 3411508 Landside, tall R&L
		3401900AK10 3401901AK10	BK037 3411460 Landside, tall R&L BK003 3492890 Share knife R BK003 3492891 Share knife L
<b>Parts to mount on landsides</b>			
		63600A 63601A 1349408 1349409 800MOL 801MOL	BK094 63600A Wearing plate, rev. R&L BK094 63601A Wearing plate, rev. R&L BK052 1349408 Sword coulters R BK052 1349409 Sword coulters L BK096 800MOL Subsoiler blade R BK096 801MOL Subsoiler blade L

Parts to fit:

## LEMKEN BU ploughbody

### Bolt box no. Articul-no. Designation

#### Shares and points

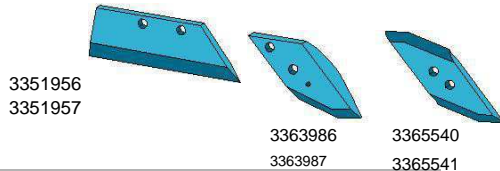

BK036	3351956	EUROSHARE 14" R
BK036	3351957	EUROSHARE 14" L
BK036	3363986	EUROPOINT rev. R
BK036	3363987	EUROPOINT rev. L
BK032	3365540	EUROPOINT R
BK032	3365541	EUROPOINT L

#### Landsides

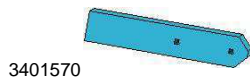

BK044	3401570	Landside, semilong R&L
-------	---------	------------------------

Parts to fit:

## LEMKEN CS Duramaxx ploughbody

#### Landsides

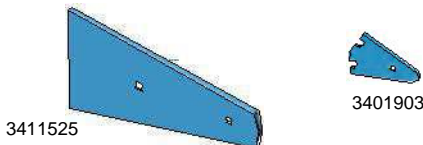

	3411525	Landside R&L
--	---------	--------------

Parts to fit:

## LEMKEN ploughs

#### Skim shares and skim mouldboards

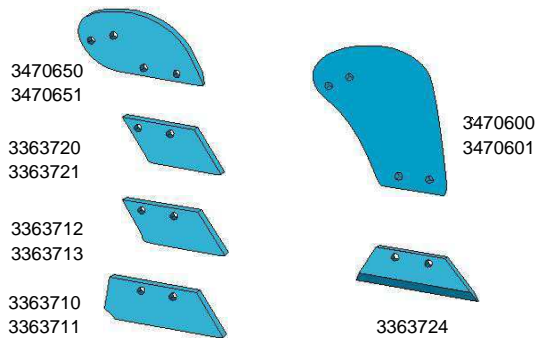

BK001	3470650	Skim mouldboard R
BK001	3470651	Skim mouldboard L
BK003	3363720	Skim share R
BK003	3363721	Skim share L
BK003	3363710	Skim share R
BK003	3363711	Skim share L
BK003	3363712	Skim share R
BK003	3363713	Skim share L
BK001	3470600	Skim mouldboard R
BK001	3470601	Skim mouldboard L
BK003	3363724	Skim share R&L

#### Disc coulters

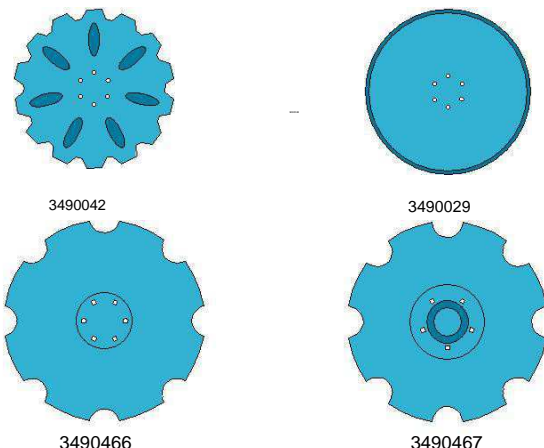

	3490029	Disc coulters, plain Ø500mm
	3490466	Disc coulters, concave, notched Ø625mm
	3490467	Disc coulters, concave, notched Ø625mm



Parts to fit:

## LEMKEN C and C40 ploughbodies

**Bolt box no. Article-no. Designation**

### Mouldboards, shins and accessories

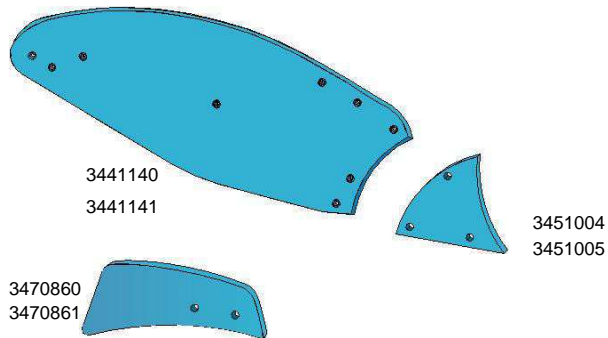

BK005	3441140	Mouldboard R
BK005	3441141	Mouldboard L
BK007	3451004	Shin R
BK007	3451005	Shin L
BK009	3470860	Turbo-trashboard R
BK009	3470861	Turbo-trashboard L

### Shares and points

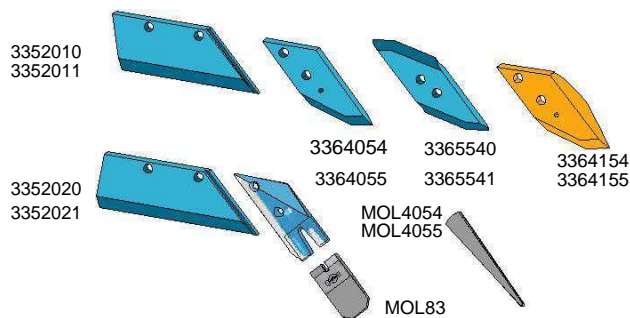

BK032	3365540	EUROPOINT rev. R
BK032	3365541	EUROPOINT rev. L
BK036	3364054	EUROPOINT R
BK036	3364055	EUROPOINT L
BK036	3364154	EUROCARBIDE M5 point R
BK036	3364155	EUROCARBIDE M5 point L
BK036	3352010	EUROSHARE 14" R
BK036	3352011	EUROSHARE 14" L
BK036	3352020	EUROSHARE 16" R
BK036	3352021	EUROSHARE 16" L
BK036	MOL4054	M7-Adapter R
BK036	MOL4055	M7-Adapter L
BK036	MOL83	M7 point
	4879058	Wedge for M7 point

### Landsides and share knives

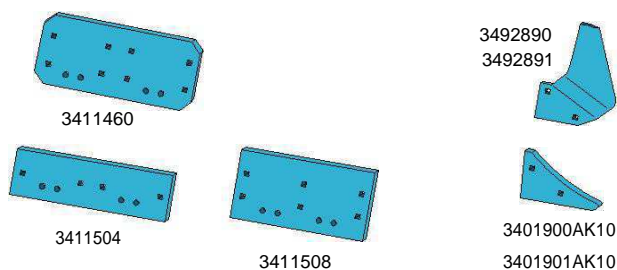

BK008	3401900AK10	Landside, front R
BK008	3401901AK10	Landside, front L
BK037	3411508	Landside, tall R&L
BK036	3411504	Landside, long R&L
BK037	3411460	Landside, tall R&L
BK003	3492890	Share knife R
BK003	3492891	Share knife L

### Parts to mount on landsides

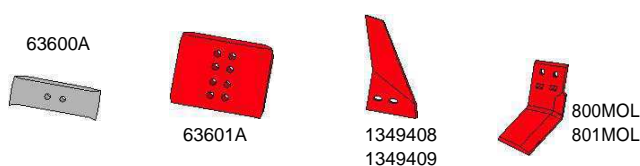

BK094	63600A	Wearing plate, rev. R&L
BK094	63601A	Wearing plate, rev. R&L
BK052	1349408	Sword coulter R
BK052	1349409	Sword coulter L
BK096	800MOL	Subsoiler blade R
BK096	801MOL	Subsoiler blade L

**Did you know...**

that Mølbros M5 EUROCARBID point is thicker than the original Lemken point.

Parts to fit:

# LEMKEN US 35 ploughbody

		<u>Bolt box no.</u>	<u>Article-no.</u>	<u>Designation</u>
<b>Mouldboards, shins and accessories</b>				
571MOL	3444130	3444120	3470860	BK009 3470860 Turbo-trashboard R
	3444131	3444121	3470861	BK009 3470861 Turbo-trashboard L
572MOL	3444134			4691MOLR Stay with support R
	3444135			4691MOLL Stay with support L
				571MOL Support for stay, short
				572MOL Support for stay, long
				BK007 3451002 Shin R (10mm)
				BK007 3451003 Shin L (10mm)
				BK010 3451010 Shin R (8mm)
				BK010 3451011 Shin L (8mm)
				BK006 3444110 Mouldboard stripe R
				BK006 3444111 Mouldboard stripe L
				BK172 3444120 Mouldboard stripe R
				BK172 3444121 Mouldboard stripe L
				BK172 3444130 Mouldboard stripe R
				BK172 3444131 Mouldboard stripe L
				BK172 3444134 Mouldboard stripe R
				BK172 3444135 Mouldboard stripe L
				BK140 4671002 Frog R
				BK140 4671003 Frog L
				BK140 4671010 Frog R
				BK140 4671011 Frog L
<b>Shares and points</b>				
				BK032 3365540 EUROPOINT rev. R
				BK032 3365541 EUROPOINT rev. L
				BK036 3364050 EUROPOINT R
				BK036 3364051 EUROPOINT L
				BK036 3364150 EUROCARBIDE M5 point R
				BK036 3364151 EUROCARBIDE M5 point L
				BK036 3352030 EUROS SHARE 18" R
				BK036 3352031 EUROS SHARE 18" L
				BK036 3352130 EUROS SHARE 18" R (11mm)
				BK036 3352131 EUROS SHARE 18" L (11mm)
				BK038 MOL2030C EUROCARBIDE share 18" R
				BK038 MOL2031C EUROCARBIDE share 18" L
				BK036 3352230 EUROCARBIDeshare M5 18" R
				BK036 3352231 EUROCARBIDeshare M5 18" L
				BK036 MOL4150 M7-Adapter R
				BK036 MOL4151 M7-Adapter L
				MOL83 M7 point
				4879058 Wedge for M7 point
<b>Landsides and share knives</b>				
				BK008 3401900AK10 Landside, front R
				BK008 3401901AK10 Landside, front L
				BK036 3411500 Landside, short R&L
				BK036 3411504 Landside, long R&L
				BK037 3411508 Landside, tall R&L
				BK037 3411460 Landside, tall R&L
				BK003 3492890 Share knife R
				BK003 3492891 Share knife L
<b>Parts to mount on landsides</b>				
				BK094 63600A Wearing plate, rev. R&L
				BK094 63601A Wearing plate, rev. R&L
				BK052 1349408 Sword coulter R
				BK052 1349409 Sword coulter L
				BK096 800MOL Subsoiler blade R
				BK096 801MOL Subsoiler blade L

Parts to fit:

# LEMKEN US 40 ploughbody

## Bolt box no. Article-no. Designation

### Mouldboards, shins and accessories

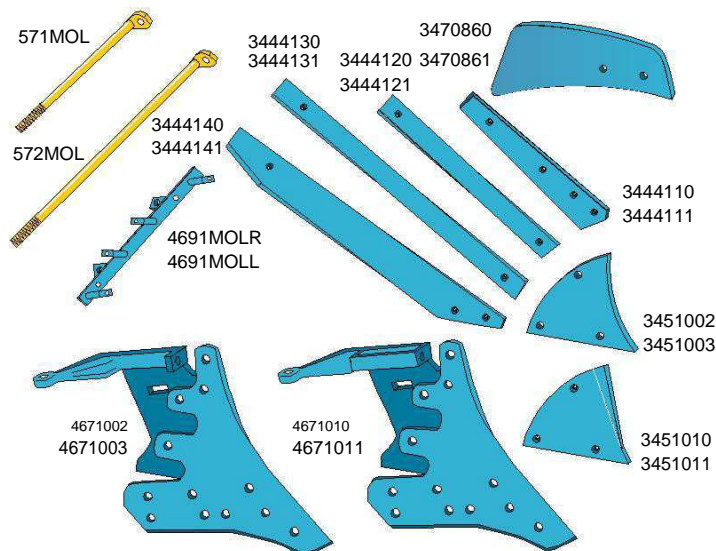

BK009	3470860	Turbo-trashboard R
BK009	3470861	Turbo-trashboard L
	4691MOLR	Stay with support R
	4691MOLL	Stay with support L
	571MOL	Support for stay, short
	572MOL	Support for stay, long
BK007	3451002	Shin R (10mm)
BK007	3451003	Shin L (10mm)
BK010	3451010	Shin R (8mm)
BK010	3451011	Shin L (8mm)
BK006	3444110	Mouldboard stripe R
BK006	3444111	Mouldboard stripe L
BK172	3444120	Mouldboard stripe R
BK172	3444121	Mouldboard stripe L
BK172	3444130	Mouldboard stripe R
BK172	3444131	Mouldboard stripe L
BK173	3444140	Mouldboard stripe R
BK173	3444141	Mouldboard stripe L
BK140	4671002	Frog R
BK140	4671003	Frog L
BK140	4671010	Frog R
BK140	4671011	Frog L

### Shares and points

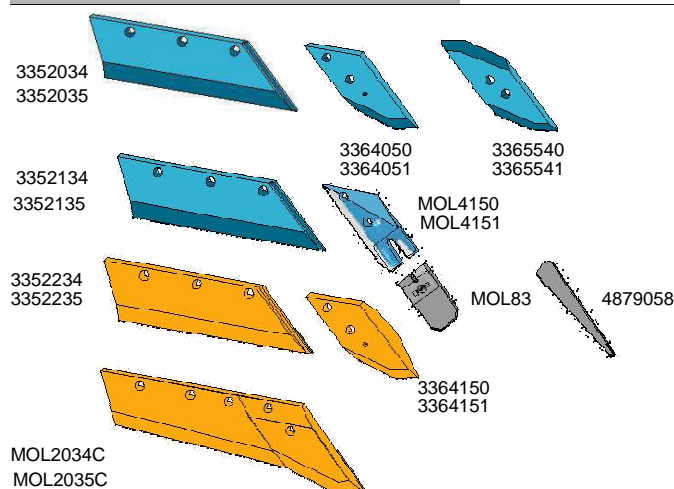

BK032	3365540	EUROPOINT rev. R
BK032	3365541	EUROPOINT rev. L
BK036	3364050	EUROPOINT R
BK036	3364051	EUROPOINT L
BK036	3364150	EUROCARBIDE M5 point R
BK036	3364151	EUROCARBIDE M5 point L
BK037	3352034	EUROSHARE 20" R
BK037	3352035	EUROSHARE 20" L
BK037	3352134	EUROSHARE 20" R (11mm)
BK037	3352135	EUROSHARE 20" L (11mm)
BK039	MOL2034C	EUROCARBIDE share 20" R
BK039	MOL2035C	EUROCARBIDE share 20" L
BK037	3352234	EUROCARBIDeshare M5 20" R
BK037	3352235	EUROCARBIDeshare M5 20" L
BK036	MOL4150	M7-Adapter R
BK036	MOL4151	M7-Adapter L
	MOL83	M7 point
	4879058	Wegde for M7 point

### Landsides and share knives

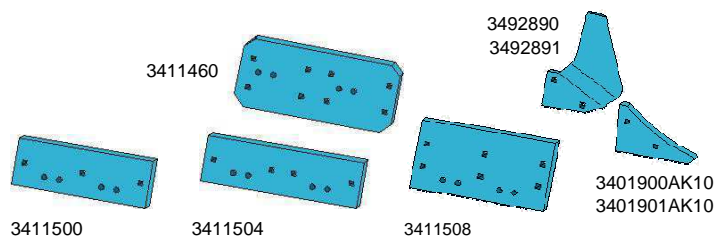

BK008	3401900AK10	Landside, front R
BK008	3401901AK10	Landside, front L
BK036	3411500	Landside, short R&L
BK036	3411504	Landside, long R&L
BK037	3411508	Landside, tall R&L
BK037	3411460	Landside, tall R&L
BK003	3492890	Share knife R
BK003	3492891	Share knife L

### Parts to mount on landsides

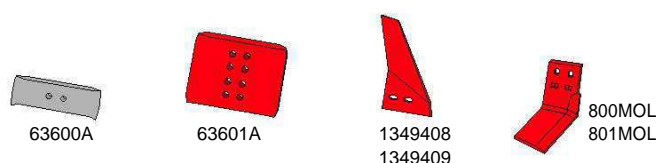

BK094	63600A	Wearing plate, rev. R&L
BK094	63601A	Wearing plate, rev. R&L
BK052	1349408	Sword coulter R
BK052	1349409	Sword coulter L
BK096	800MOL	Subsoiler blade R
BK096	801MOL	Subsoiler blade L



Parts to fit:

## LEMKEN WG ploughbody

**Bolt box no. Article-no. Designation**

### Shins

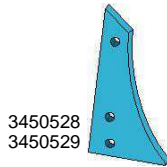

<i>BK010</i>	3450528	Shin R
<i>BK010</i>	3450529	Shin L

### Shares and knives

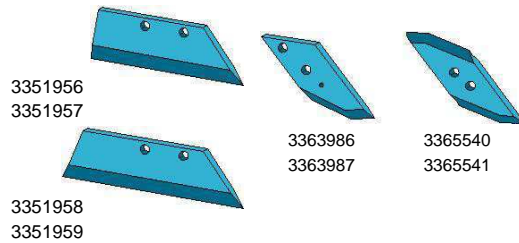

<i>BK032</i>	3365540	EUROPOINT rev. R
<i>BK032</i>	3365541	EUROPOINT rev. L
<i>BK036</i>	3363986	EUROPOINT R
<i>BK036</i>	3363987	EUROPOINT L
<i>BK036</i>	3351956	EUROSHARE 14" R
<i>BK036</i>	3351957	EUROSHARE 14" L
<i>BK036</i>	3351958	EUROSHARE 16" R
<i>BK036</i>	3351959	EUROSHARE 16" L

### Landside

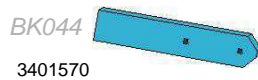

<i>BK044</i>	3401570	Landside, semi long R&L
--------------	---------	-------------------------

Parts to fit:

## LEMKEN OPAL ploughbody

### Beams and accessories

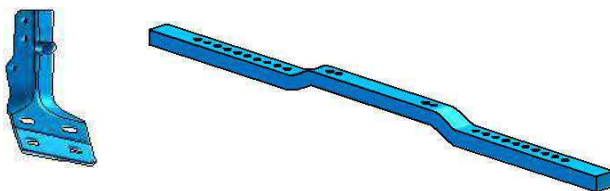

	4570840	Frog 50x30x10 R
	4570841	Frog 50x30x10 L
	4644991	Beam L&R

Parts to fit:

## LEMKEN WS ploughbody

### Points

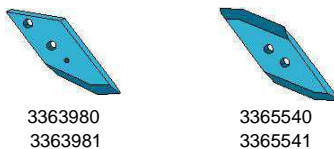

<i>BK032</i>	3365540	EUROPOINT rev. R
<i>BK032</i>	3365541	EUROPOINT rev. L
<i>BK036</i>	3363980	EUROPOINT R
<i>BK036</i>	3363981	EUROPOINT L

### Landside

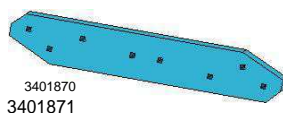

<i>BK038</i>	3401870	Landside, semilong R
<i>BK038</i>	3401871	Landside, semilong L



Parts to fit:

## MASSEY-FERGUSON FC ploughbody

Numbers in ( ) are original Massey-Ferguson numbers.

Please use art. no. **without** ( ), when ordering.

### Bolt box no. Article-no. Designation

#### Mouldboards, shins and accessories

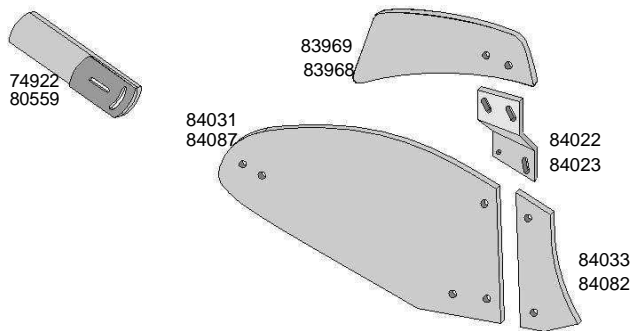

BK167	83969 (3940301)	Turbo-trashboard R
BK167	83968 (3940300)	Turbo-trashboard L
	84022 (3940303)	Fittings for trashboard R
	84023 (3940304)	Fittings for trashboard L
BK062	84031 (3940305)	Mouldboard R
BK062	84087 (3940317)	Mouldboard L
BK082	74922 (3940234)	Mouldboard extension R
BK082	80559 (3940262)	Mouldboard extension L
BK065	84033 (3940306)	Shin R
BK065	84082 (3940315)	Shin L

#### Shares and points

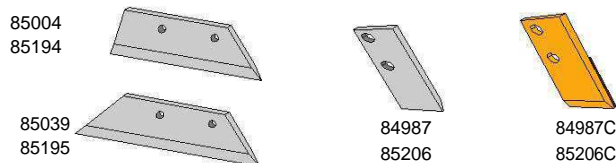

BK052	85004 (3940330)	EUROSHARE 16" R
BK052	85194 (3940334)	EUROSHARE 16" L
BK052	85039 (3940332)	EUROSHARE 18" R
BK052	85195 (3940335)	EUROSHARE 18" L
BK031	84987 (3940328)	EUROPOINT R
BK031	85206 (3940337)	EUROPOINT L
BK031	84987C	EUROCARBIDE M5 point R
BK031	85206C	EUROCARBIDE M5 point L

#### Landsides and share knives

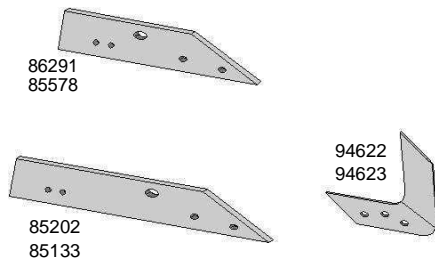

BK084	94622 (3940746)	Share knife R
BK084	94623 (3940745)	Share knife L
BK073	86291 (3940391)	Landside, short R
BK073	85578 (3940359)	Landside, short L
BK073	85202 (3940700)	Landside, long R
BK073	85133 (3940810)	Landside, long L

#### Parts to mount on landsides

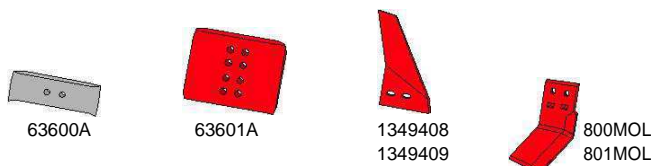

BK094	63600A	Wearing plate, rev. R&L
BK094	63601A	Wearing plate, rev. R&L
BK052	1349408	Sword coulter R
BK052	1349409	Sword coulter L
BK096	800MOL	Subsoiler blade R
BK096	801MOL	Subsoiler blade L

### Did you know...

that all Mølbro's landsides are equipped with mounting holes for our range of landside accessories?

Parts to fit:

## MASSEY-FERGUSON AH ploughbody

Numbers in ( ) are original Massey-Ferguson numbers.

Please use art. no. **without** ( ), when ordering.

### Bolt box no. Article-no. Designation

#### Mouldboards, shins and accessories

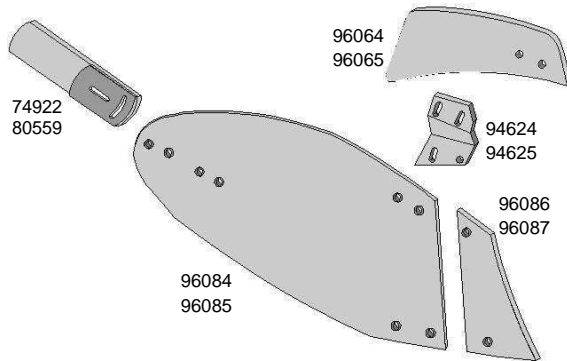

BK082	74922 (3940234)	Mouldboard extension R
BK082	80559 (3940262)	Mouldboard extension L
BK167	96064 (3941789)	Turbo-trashboard R
BK167	96065 (3941790)	Turbo-trashboard L
BK082	94624 (3942733)	Fittings for trashboard R
BK082	94625 (3942732)	Fittings for trashboard L
BK067	96084 (3941973)	Mouldboard R
BK067	96085 (3941972)	Mouldboard L
BK052	96086 (3941975)	Shin R
BK052	96087 (3941974)	Shin L

#### Shares and points

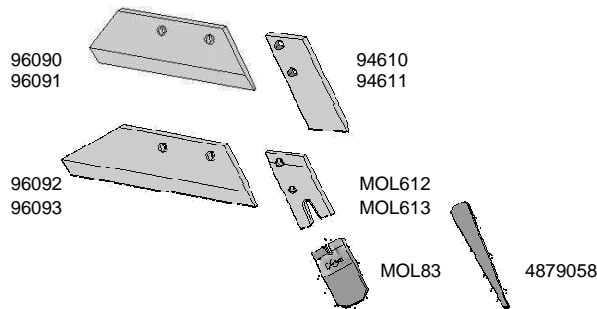

BK052	96090 (39411969)	EUROSHARE 16" R
BK052	96091 (39411968)	EUROSHARE 16" L
BK052	96092 (39411971)	EUROSHARE 18" R
BK052	96093 (39411970)	EUROSHARE 18" L
BK031	94610 (3940742)	EUROPOINT R
BK031	94611 (3940741)	EUROPOINT L
BK031	MOL612	M7-Adapter R
BK031	MOL613	M7-Adapter L
	MOL83	M7 point rev. R/L
	4879058	Wegde for M7 point

#### Landsides and share knives

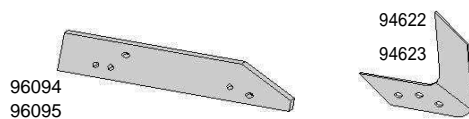

BK069	96094 (39411967)	Landside R
BK069	96095 (39411966)	Landside L
BK084	94622 (3940746)	Share knife R
BK084	94623 (3940745)	Share knife L

#### Parts to mount on landsides

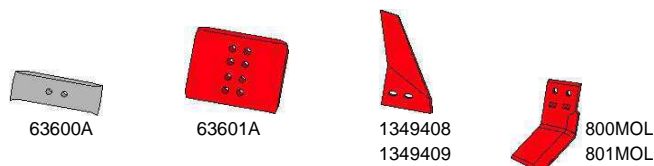

BK094	63600A	Wearing plate, rev. R&L
BK094	63601A	Wearing plate, rev. R&L
BK052	1349408	Sword coulter R
BK052	1349409	Sword coulter L
BK096	800MOL	Subsoiler blade R
BK096	801MOL	Subsoiler blade L

Parts to fit:

## MASSEY-FERGUSON AS ploughbody

Numbers in ( ) are original Massey-Ferguson numbers.

Please use art. no. **without** ( ), when ordering.

### Bolt box no. Article-no. Designation

#### Mouldboards, shins and accessories

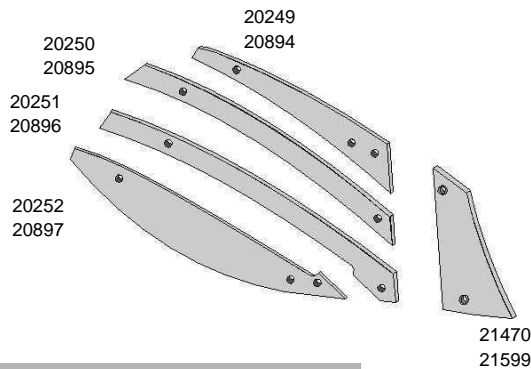

<i>BK058</i>	20249 (3942705)	Mouldboard stripe R
<i>BK058</i>	20894 (3942712)	Mouldboard stripe L
<i>BK052</i>	20250 (3942706)	Mouldboard stripe R
<i>BK052</i>	20895 (3942713)	Mouldboard stripe L
<i>BK052</i>	20251 (3942707)	Mouldboard stripe R
<i>BK052</i>	20896 (3942714)	Mouldboard stripe L
<i>BK058</i>	20252 (3942708)	Mouldboard stripe R
<i>BK058</i>	20897 (3942715)	Mouldboard stripe L
<i>BK052</i>	21470 (3942730)	Shin R
<i>BK052</i>	21599 (3942729)	Shin L

#### Shares and points

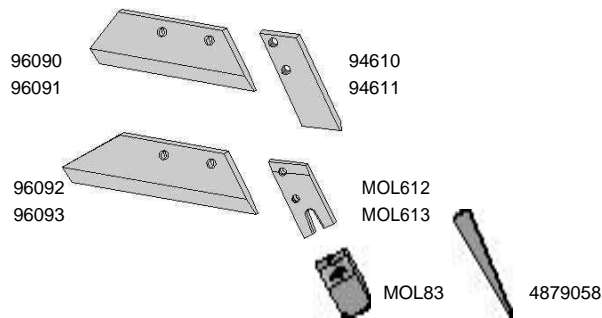

<i>BK052</i>	96090 (39411969)	EUROSHARE 16" R
<i>BK052</i>	96091 (39411968)	EUROSHARE 16" L
<i>BK052</i>	96092 (39411971)	EUROSHARE 18" R
<i>BK052</i>	96093 (39411970)	EUROSHARE 18" L
<i>BK031</i>	94610 (3940742)	EUROPOINT R
<i>BK031</i>	94611 (3940741)	EUROPOINT L
<i>BK031</i>	MOL612	M7-Adapter R
<i>BK031</i>	MOL613	M7-Adapter L
	MOL83	M7 point rev. R/L
	4879058	Wegde for M7 point

#### Landsides and share knives

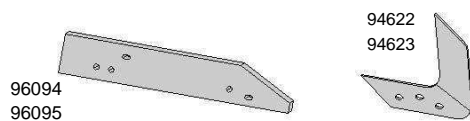

<i>BK069</i>	96094 (39411967)	Landside R
<i>BK069</i>	96095 (39411966)	Landside L
<i>BK084</i>	94622 (3940746)	Share knife R
<i>BK084</i>	94623 (3940745)	Share knife L

#### Parts to mount on landsides

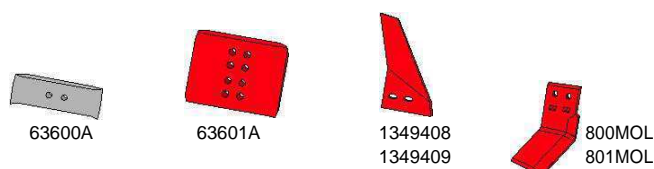

<i>BK094</i>	63600A	Wearing plate, rev. R&L
<i>BK094</i>	63601A	Wearing plate, rev. R&L
<i>BK052</i>	1349408	Sword coulter R
<i>BK052</i>	1349409	Sword coulter L
<i>BK096</i>	800MOL	Subsoiler blade R
<i>BK096</i>	801MOL	Subsoiler blade L

Parts to fit:

## MASSEY-FERGUSON AX ploughbody

Numbers in ( ) are original Massey-Ferguson numbers.

Please use art. no. **without** ( ), when ordering.

### Bolt box no. Article-no. Designation

#### Mouldboards, shins and accessories

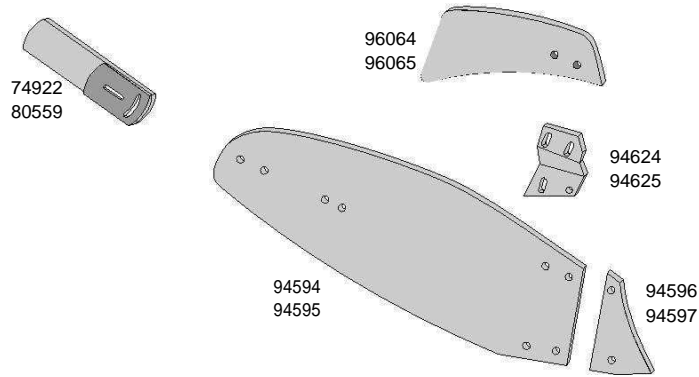

<i>BK082</i>	74922 (3940234)	Mouldboard extension R
<i>BK082</i>	80559 (3940262)	Mouldboard extension L
<i>BK167</i>	96064 (3941789)	Turbo-trashboard R
<i>BK167</i>	96065 (3941790)	Turbo-trashboard L
<i>BK082</i>	94624 (3942733)	Fittings for trashboard R
<i>BK082</i>	94625 (3942732)	Fittings for trashboard L
<i>BK066</i>	94594 (3940744)	Mouldboard R
<i>BK066</i>	94595 (3940743)	Mouldboard L
<i>BK052</i>	94596 (3940704)	Shin R
<i>BK052</i>	94597 (3940705)	Shin L

#### Shares and points

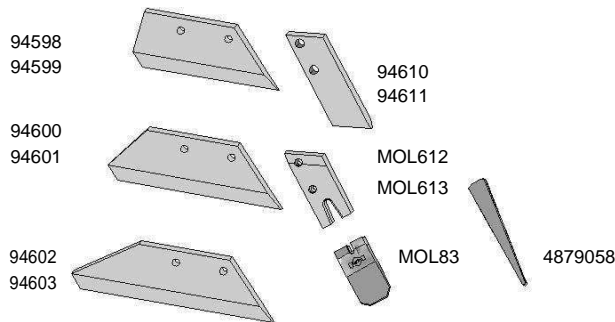

<i>BK052</i>	94598 (3940706)	EUROSHARE 14" R
<i>BK052</i>	94599 (3940707)	EUROSHARE 14" L
<i>BK052</i>	94600 (3940708)	EUROSHARE 16" R
<i>BK052</i>	94601 (3940709)	EUROSHARE 16" L
<i>BK052</i>	94602 (3940710)	EUROSHARE 18" R
<i>BK052</i>	94603 (3940711)	EUROSHARE 18" L
<i>BK031</i>	94610 (3940742)	EUROPOINT R
<i>BK031</i>	94611 (3940741)	EUROPOINT L
<i>BK031</i>	MOL612	M7-Adapter R
<i>BK031</i>	MOL613	M7-Adapter L
	MOL83	M7 point rev. R/L
	4879058	Wedge for M7 point

#### Landsides and share knives

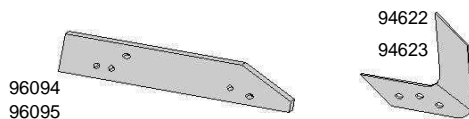

<i>BK074</i>	94606 (3940714)	Landside R
<i>BK074</i>	94607 (3940715)	Landside L
<i>BK084</i>	94622 (3940746)	Share knife R
<i>BK084</i>	94623 (3940745)	Share knife L

#### Parts to mount on landsides

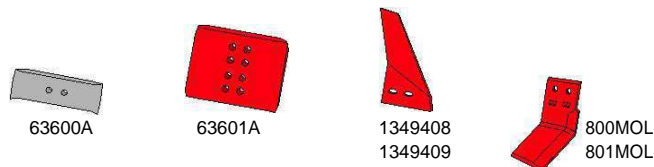

<i>BK094</i>	63600A	Wearing plate, rev. R&L
<i>BK094</i>	63601A	Wearing plate, rev. R&L
<i>BK052</i>	1349408	Sword coulters R
<i>BK052</i>	1349409	Sword coulters L
<i>BK096</i>	800MOL	Subsoiler blade R
<i>BK096</i>	801MOL	Subsoiler blade L



Parts to fit:

## MASSEY-FERGUSON FK ploughbody

Numbers in ( ) are original Massey-Ferguson numbers.

Please use art. no. **without** ( ), when ordering.

### Bolt box no. Article-no. Designation

#### Mouldboard, shin and accessories

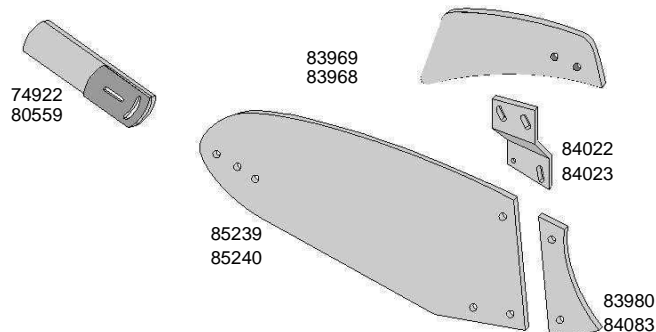

- BK167 83969 (3940301) Turbo-trashboard R
- BK167 83968 (3940300) Turbo-trashboard L
- 84022 (3940303) Fittings for trashboard R
- 84023 (3940304) Fittings for trashboard L
- BK063 85239 (3940342) Mouldboard R
- BK063 85240 (3940343) Mouldboard L
- BK082 74922 (3940234) Mouldboard extension R
- BK082 80559 (3940262) Mouldboard extension L
- BK065 83980 (3940302) Shin R
- BK065 84083 (3940316) Shin L

#### Shares and points

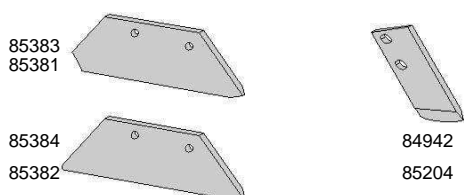

- BK052 85383 (3940312) EUROSHARE 14" R
- BK052 85381 (3940314) EUROSHARE 14" L
- BK052 85384 (3940347) EUROSHARE 16" R
- BK052 85382 (3940345) EUROSHARE 16" L
- BK031 84942 (3940326) EUROPOINT R
- BK031 85204 (3940336) EUROPOINT L

#### Landsides and share knives

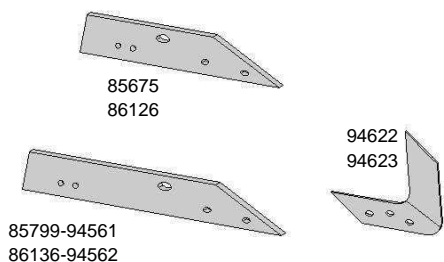

- BK084 94622 (3940746) Share knife R
- BK084 94623 (3940745) Share knife L
- BK073 85675 (3940363) Landside, short R
- BK073 86126 (3940385) Landside, short L
- BK073 85799-94561 Landside, long R (3940740)
- BK073 86136-94562 Landside, long L (3940701)

#### Parts to mount on landsides

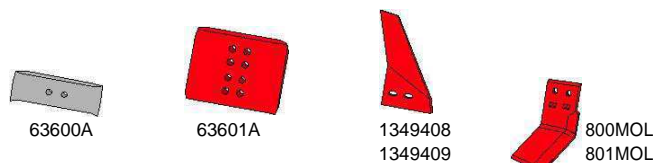

- BK094 63600A Wearing plate, rev. R&L
- BK094 63601A Wearing plate, rev. R&L
- BK052 1349408 Sword coulter R
- BK052 1349409 Sword coulter L
- BK096 800MOL Subsoiler blade R
- BK096 801MOL Subsoiler blade L

Parts to fit:

## MASSEY-FERGUSON ploughs

Numbers in ( ) are original Massey-Ferguson numbers.

Please use art. no. **without** ( ), when ordering.

### Bolt box no. Article-no. Designation

#### Skim shares and skim mouldboards

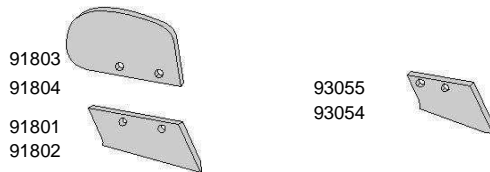

<i>BK052</i>	91803 (3940501)	Skim mouldboard R
<i>BK052</i>	91804 (3940502)	Skim mouldboard L
<i>BK052</i>	91801 (3940499)	Skim share R
<i>BK052</i>	91802 (3940500)	Skim share L
<i>BK052</i>	93055 (3940770)	Skim share R
<i>BK052</i>	93054 (3940771)	Skim share L

#### Disc coulters and accessories

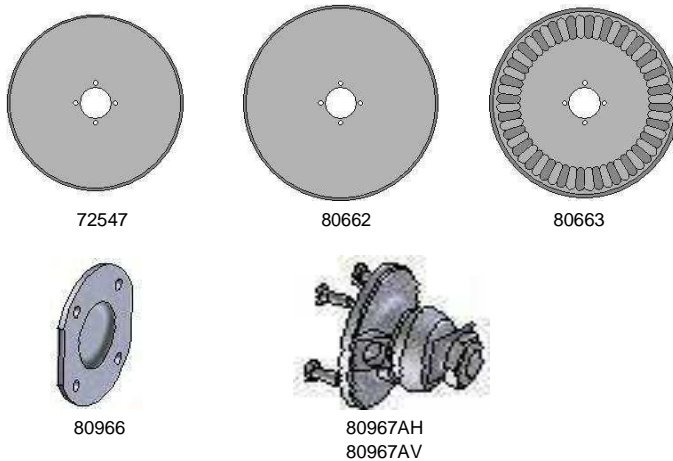

72547(3940221)	Disc coulters 18" R&L
80662 (3940268)	Disc coulters 20" R&L
80663 (3940269)	Disc coulters, rippled 20" R&L
80966 (3940277)	Cover for disc coulters R&L
80967AH	Hub for disc coulters M30 R
80967AV	Hub for disc coulters M30 L

Parts to fit:

## KRONE KG ploughs

#### Shares and points

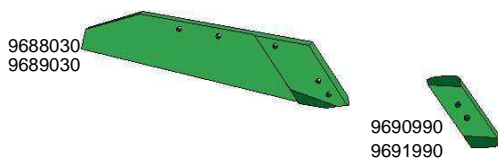

<i>BK099</i>	09688030	EUROSHARE f/rev. point R
<i>BK099</i>	09689030	EUROSHARE f/rev. point L
<i>BK101</i>	09690990	EUROPOINT rev. R
<i>BK101</i>	09691990	EUROPOINT rev. L

#### Landsides

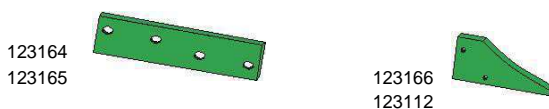





0123164	Landside, long R	
0123165	Landside, long L	
<i>BK098</i>	0123166	Landside, front R
<i>BK098</i>	0123112	Landside, front L

Parts to fit:



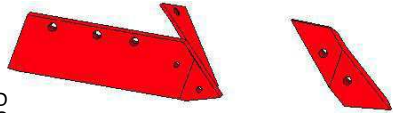

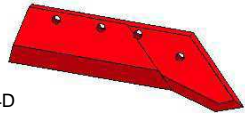

## NAUD ploughs

**Bolt box no. Article-no. Designation**

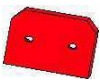
### Shares and points

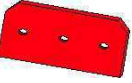
 N031189D N031189G	 N031235D N031235G	N031189D	EUROSHARE R
		N031189G	EUROSHARE L
 03055504D 03055504G	 N031235D N031235G	N031235D	EUROPOINT R
		N031235G	EUROPOINT L
		03055504D	EUROSHARE R
		03055504G	EUROSHARE L

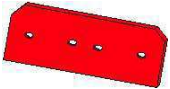
### Landsides and share knives

 N031190	 N031194D N031194G	N031190	Landside R&L
		N031191	Landside R&L
 N031191	 N031193D N031193G	N031192	Landside R&L
		N031193D	Share knife R
 N031192	 N031193D N031193G	N031193G	Share knife L
		N031194D	Share knife R
		N031194	Share knife L

### Skim share

 N031241D N031241G	N031241D	Skim share
	N031241G	Skim share

Parts to fit:

## NIEMEYER ploughs

### Shares and points

 200614R 200615L	 200616R 200617L	 024104R 024105L	BK037 200614R	EUROSHARE R
			BK037 200615L	EUROSHARE L
			BK037 200616R	EUROSHARE f/rev. point R
			BK037 200617L	EUROSHARE f/rev. point L
			BK094 024104R	EUROPOINT, rev. R
			BK094 024105L	EUROPOINT, rev. L

Parts to fit:

# PÖTTINGER ploughbodies 36W and 41W

Mouldboards, shins and accessories		Bolt box no.	Article-no.	Designation
73800		BK167	73/63-300	Turbo-trashboard R
73801		BK167	73/63-301	Turbo-trashboard L
53387			73/63-310	Fittings for trashboard R
63388			73/63-311	Fittings for trashboard L
73803		BK156	73803	Brace R&L
73290		BK113	73800	Brace fitting R
73291		BK113	73801	Brace fitting L
73286		BK082	53387	Mouldboard extension R
73287		BK082	63388	Mouldboard extension L
		BK059	73290	Mouldboard R
		BK059	73291	Mouldboard L
		BK056	73286	Mouldboard R
		BK056	73287	Mouldboard L
		BK058	73256	Shin R
		BK058	73257	Shin L
		BK052	73250	Shin R
		BK052	73251	Shin L
			73266	Bracket for shin R
			73267	Bracket for shin L
			93070	Frog R
			93071	Frog L
Shares, points and accessories				
073002		BK113	073002	EUROSHARE 14" R
073003		BK113	073003	EUROSHARE 14" L
073004		BK113	073004	EUROSHARE 16" R
073005		BK113	073005	EUROSHARE 16" L
073006		BK114	073006	EUROSHARE 18" R
073007		BK114	073007	EUROSHARE 18" L
073008		BK114	073008	EUROSHARE 20" R
073009		BK114	073009	EUROSHARE 20" L
		BK170	83018	EUROSHARE M5 16" R
		BK170	83019	EUROSHARE M5 16" L
		BK170	83020	EUROSHARE M5 18" R
		BK170	83021	EUROSHARE M5 18" L
		BK170	83022	EUROSHARE M5 20" R
		BK170	83023	EUROSHARE M5 20" L
		BK144	83010C	EUROCARBIDE M5 point R
		BK144	83011C	EUROCARBIDE M5 point L
		BK144	MOL83-0	M7-adaptor R
		BK144	MOL83-1	M7-adaptor L
			MOL83	M7 point rev. R/L
			4879058	Wegde for M7 point
		BK095	73091	Share knife R
		BK095	73092	Share knife L
		BK094	53090	EUROPOINT Rev. R
		BK094	63090	EUROPOINT Rev. L
		BK095	5309MOLC	EUROCARBIDE point R
		BK095	6309MOLC	EUROCARBIDE point L
			73414	Bracket for 18" and 20" shares R
			73415	Bracket for 18" and 20" shares L
		BK170	MOL83018C	EUROCARBIDE M5 share 16" R
		BK170	MOL83019C	EUROCARBIDE M5 share 16" L
Landsides and share knives				
			929100101	Landside, long R&L
		BK095	930700050	Skim point R
		BK095	930710050	Skim point L



Parts to fit:

# PÖTTINGER ploughbody 46W

**Mouldboards, shins and accessories** **Bolt box no. Article-no. Designation**

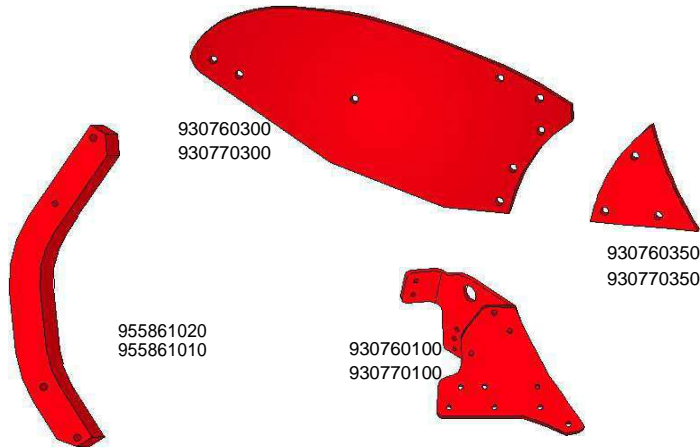

	930760300	Mouldboard R
	930770300	Mouldboard L
<i>BK077</i>	930760350	Shin R
<i>BK077</i>	930770350	Shin L
	930760100	Frog R
	930770100	Frog L
	955861020	Beam, R
	955861010	Beam, L

**Shares, points and accessories**

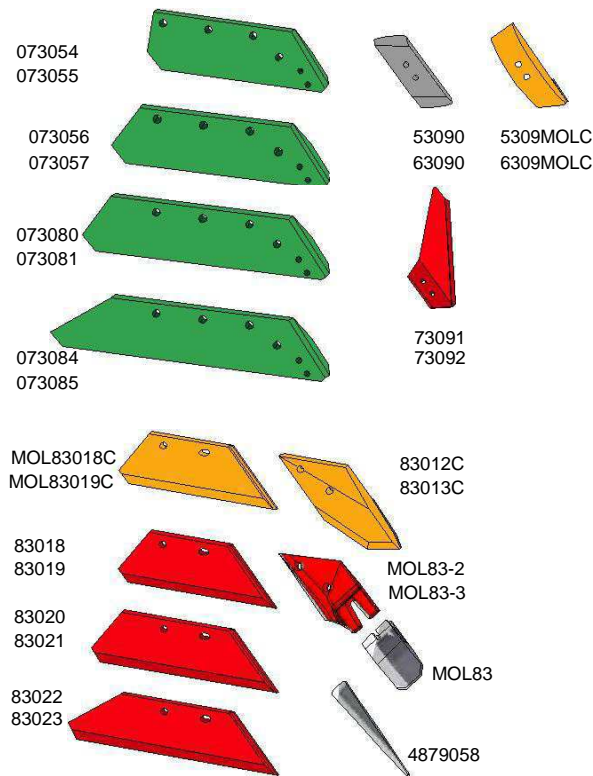

<i>BK113</i>	073054	EUROSHARE 14" R
<i>BK113</i>	073055	EUROSHARE 14" L
<i>BK113</i>	073056	EUROSHARE 16" R
<i>BK113</i>	073057	EUROSHARE 16" L
<i>BK113</i>	073080	EUROSHARE 18" R
<i>BK113</i>	073081	EUROSHARE 18" L
<i>BK113</i>	073084	EUROSHARE 20" R
<i>BK113</i>	073085	EUROSHARE 20" L
<i>BK095</i>	73091	Share knife R
<i>BK092</i>	73092	Share knife L
<i>BK094</i>	53090	EUROPOINT Rev. R
<i>BK094</i>	63090	EUROPOINT Rev. L
<i>BK095</i>	5309MOLC	EUROCARBIDE point R
<i>BK095</i>	6309MOLC	EUROCARBIDE point L
<i>BK170</i>	83018	EUROSHARE M516" R
<i>BK170</i>	83019	EUROSHARE M5 16" L
<i>BK170</i>	83020	EUROSHARE M5 18" R
<i>BK170</i>	83021	EUROSHARE M5 18" L
<i>BK170</i>	83022	EUROSHARE M5 20" R
<i>BK170</i>	83023	EUROSHARE M5 20" L
<i>BK144</i>	83012C	EUROCARBIDE M5 point R
<i>BK144</i>	83013C	EUROCARBIDE M5 point L
<i>BK144</i>	MOL83-0	M7-adapter R
<i>BK144</i>	MOL83-1	M7-adapter L
	MOL83	M7 point rev. R/L
	4879058	Wegde for M7 point
<i>BK170</i>	MOL83018C	EUROCARBIDE M5share16" R
<i>BK170</i>	MOL83019C	EUROCARBIDE M5share16" L

**Landsides**

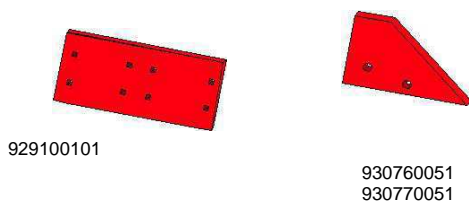

	929100101	Landside, long R&L
<i>BK095</i>	930760051	Landside, front R
<i>BK095</i>	930770051	Landside, front L

Parts to fit

# RABEWERK ploughbodies BP-321, 322, 323 PS/PSL

## Bolt box no. Article-no. Designation

### Mouldboards, shins and accessories

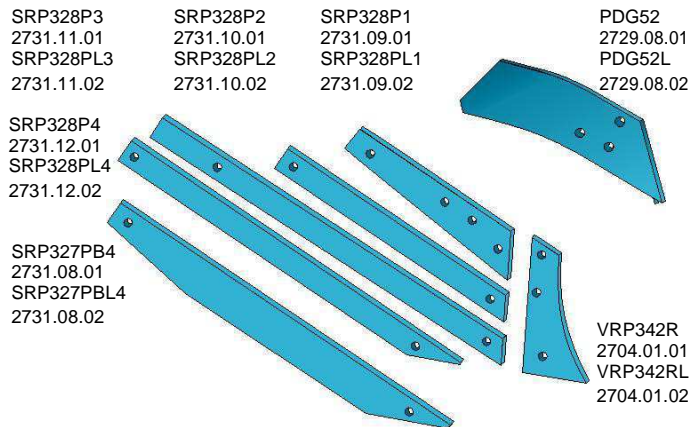

<i>BK077</i>	PDG52	Trashboard R
<i>BK077</i>	PDG52L	Trashboard L
<i>BK078</i>	SRP328P1	Mouldboard stripe R
<i>BK078</i>	SRP328PL1	Mouldboard stripe L
<i>BK069</i>	SRP328P2	Mouldboard stripe R
<i>BK069</i>	SRP328PL2	Mouldboard stripe L
<i>BK069</i>	SRP328P3	Mouldboard stripe R
<i>BK069</i>	SRP328PL3	Mouldboard stripe L
<i>BK069</i>	SRP328P4	Mouldboard stripe R
<i>BK069</i>	SRP328PL4	Mouldboard stripe L
<i>BK069</i>	SRP327PB4	Mouldboard stripe R
<i>BK069</i>	SRP327PBL4	Mouldboard stripe L
<i>BK058</i>	VRP342R	Shin R (10 mm)
<i>BK058</i>	VRP342RL	Shin L (10 mm)

### Shares and points

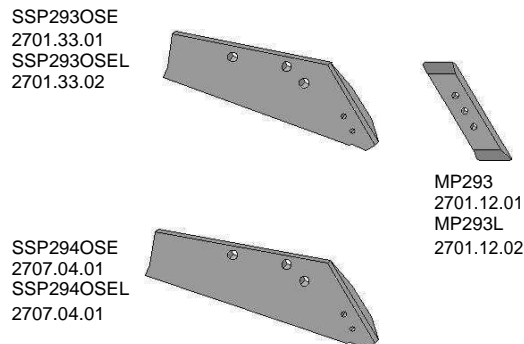

<i>BK094</i>	MP293	EUROPOINT, rev. R
<i>BK094</i>	MP293L	EUROPOINT, rev. L
<i>BK037</i>	SSP293OSE	EUROSHARE R
<i>BK037</i>	SSP293OSEL	EUROSHARE L
<i>BK037</i>	SSP294OSE	EUROSHARE R
<i>BK037</i>	SSP294OSEL	EUROSHARE L

### Landsides and share knives

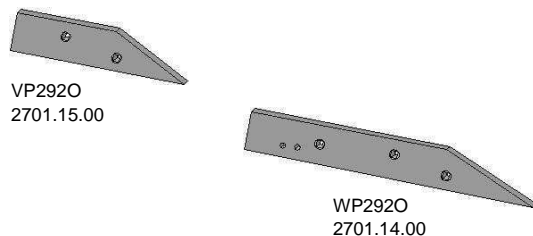

<i>BK033</i>	VP292O	Landside, short R&L
<i>BK040</i>	WP292O	Landside, long R&L

### Parts to mount on landsides

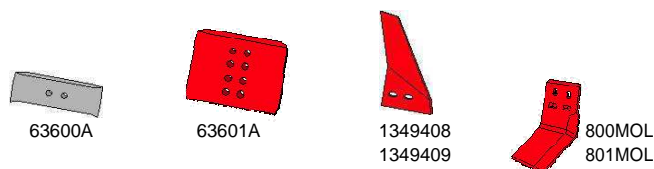

<i>BK094</i>	63600A	Wearing plate, rev. R&L
<i>BK094</i>	63601A	Wearing plate, rev. R&L
<i>BK052</i>	1349408	Sword coulter R
<i>BK052</i>	1349409	Sword coulter L
<i>BK096</i>	800MOL	Subsoiler blade R
<i>BK096</i>	801MOL	Subsoiler blade L

Parts to fit:

## RABEWERK ploughbodies BP-350 WS/WSL

### Bolt box no. Article-no. Designation

Mouldboards, shins and accessories						
SRP350W3 2755.03.01	SRP350W2 2755.02.01	SRP350W1 2755.01.01	PDG52 2729.08.01	BK077	PDG52	Trashboard R
SRP350WL3 2755.03.02	SRP350WL2 2755.02.02	SRP350WL1 2755.01.02	PDG52L 2729.08.02	BK077	PDG52L	Trashboard L
SRP350W4 2755.04.01				BK052	SRP350W1	Mouldboard stripe R
SRP350WL4 2755.04.02				BK052	SRP350WL1	Mouldboard stripe L
				BK052	SRP350W2	Mouldboard stripe R
				BK052	SRP350WL2	Mouldboard stripe L
				BK052	SRP350W3	Mouldboard stripe R
				BK052	SRP350WL3	Mouldboard stripe L
				BK052	SRP350W4	Mouldboard stripe R
				BK052	SRP350WL4	Mouldboard stripe L
				BK052	SRP350W41	Mouldboard stripe R
				BK052	SRP350WL41	Mouldboard stripe L
SRP350W41 2755.07.01				BK069	VRP350W	Shin R (10 mm)
SRP350WL41 2755.07.02				BK069	VRP350WL	Shin L (10 mm)

Shares and Knives						
SSP350WSE 2751.22.01				BK094	MP350	EUROPOINT, rev. R
SSP350WSEL 2751.22.02				BK094	MP350L	EUROPOINT, rev. L
				BK095	MOL350C	EUROCARBIDE M3 point R
				BK095	MOL350LC	EUROCARBIDE M3 point L
SSP351WEP 2751.30.01				BK038	SSP350WSE	EUROSHARE R
SSP351WEPL 2751.30.02				BK038	SSP350WSEL	EUROSHARE L
				BK038	SSP351WEP	EUROCARBIDE share R
				BK038	SSP351WEPL	EUROCARBIDE share L

Landsides and share knives						
WP351W 2751.03.05				BK042	WP351W	Landside, rev. R&L
VP351W 2751.03.06				BK042	VP351W	Landside, short, rev. R&L
				BK041	YP350W	Skim point, rev. R&L

**Did you know...**

*that Mølbro process about 4000 tons best boron steel from Scandinavia per year?*

Parts to fit:

## RABEWERK ploughbodies BP-2930, 2940 L

### Bolt box no. Article-no. Designation

#### Mouldboards, shins and accessories

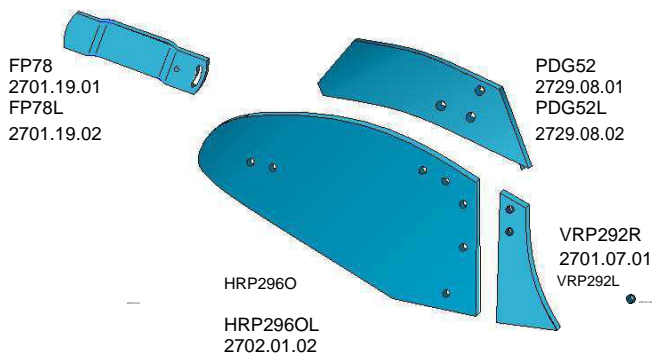

BK077	PDG52	Trashboard R
BK077	PDG52L	Trashboard L
	FP78	Mouldboard extension R
	FP78L	Mouldboard extension L
	HRP296O	Mouldboard R
	HRP296OL	Mouldboard L
BK058	VRP292R	Shin R
BK058	VRP292L	Shin L

#### Shares and points

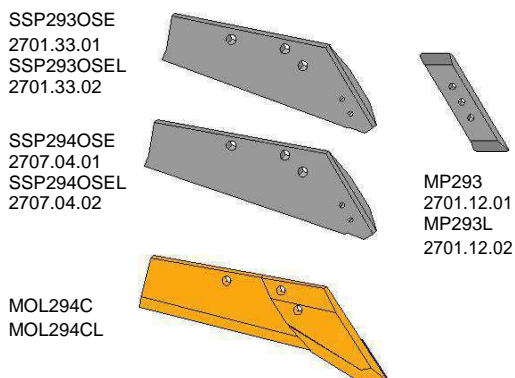

BK094	MP293	EUROPOINT, rev. R
BK094	MP293L	EUROPOINT, rev. L
BK037	SSP293OSE	EUROSHARE R
BK037	SSP293OSEL	EUROSHARE L
BK037	SSP294OSE	EUROSHARE R
BK037	SSP294OSEL	EUROSHARE L
BK037	MOL294C	EUROCARBIDE share 18" R
BK037	MOL294CL	EUROCARBIDE share 18" L

#### Landsides

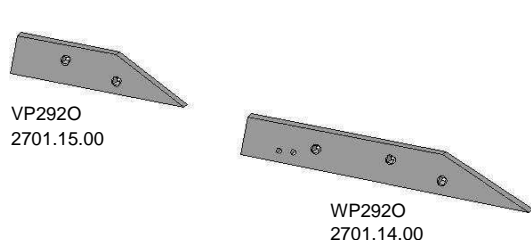

BK033	VP292O	Landside, short R&L
BK040	WP292O	Landside, long R&L

#### Parts to mount on landsides

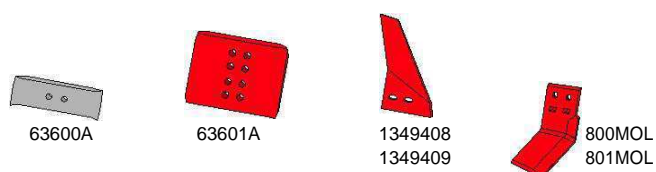

BK094	63600A	Wearing plate, rev. R&L
BK094	63601A	Wearing plate, rev. R&L
BK052	1349408	Sword coulter R
BK052	1349409	Sword coulter L
BK096	800MOL	Subsoiler blade R
BK096	801MOL	Subsoiler blade L



Parts to fit:

## RABEWERK universal wearing parts

**Bolt box no. Article-no. Designation**

### Shares and points

SSP332OSE  
2708.27.02  
SSP332OSEL  
2708.27.02

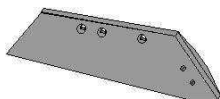

BK037 SSP332OSE EUROSHARE R  
BK037 SSP332OSEL EUROSHARE L

BK037 SSP333OSE EUROSHARE R  
BK037 SSP333OSEL EUROSHARE L

SSP333OSE  
2753.15.01  
SSP333OSEL  
2753.15.02

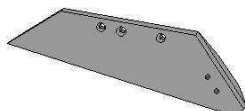

MP332  
2708.28.01  
MP332L  
2708.28.02

PK801101  
PK801102

BK037 SSP200JB Ploughshare f/rev. point L  
BK037 SSP200JBL EUROSHARE 18" R

SSP200JB  
2708.16.01  
SSP200JBL  
2708.16.02

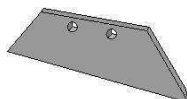

BK094 Mp332 EUROPOINT rev. R  
BK094 MP332L EUROPOINT rev. L

BK094 PK801101 EUROPOINT rev. R  
BK094 PK801102 EUROPOINT rev. L

### Skim shares



SDG14/16  
2742.02.01  
SDG14/16L  
2742.02.02



SDG181  
2715.01.01  
SDG181L  
2715.01.02

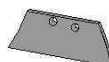

SDG18  
2715.05.01  
SDG18L  
2715.05.02

BK003 SDG14/16 Skim share R  
BK003 SDG14/16L Skim share L

BK001 SDG181 Skim share R  
BK001 SDG181L Skim share L

BK001 SDG18 Skim share R  
BK001 SDG18L Skim share L

### Disc coulters

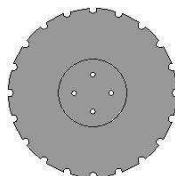

9031.13.29

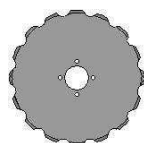

9008.55.10

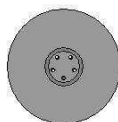

9022.52.11

9031.13.29 Disc coulters, notched Ø445mm  
9022.52.11 Disc coulters, notched Ø355mm

**Did you know...**

*that Mølbros produce all discs in best boron steel quality?*

Parts to fit:

## RABEWERK universal ploughbody (Lemken)

Mouldboards, shins and accessories		Bolt box no.	Article-no.	Designation
	571MOL	BK009	3470860	Turbo-trashboard R
	572MOL	BK009	3470861	Turbo-trashboard L
	4691MOLR		4691MOLR	Stay with support R
	4691MOLL		4691MOLL	Stay with support L
	2101002		571MOL	Support for stay, short
	2101003		572MOL	Support for stay, long
		BK007	3451002	Shin R (10mm)
		BK007	3451003	Shin L (10mm)
		BK010	3451010	Shin R (8mm)
		BK010	3451011	Shin L (8mm)
		BK006	3444110	Mouldboard stripe R
		BK006	3444111	Mouldboard stripe L
		BK172	3444120	Mouldboard stripe R
		BK172	3444121	Mouldboard stripe L
		BK172	3444130	Mouldboard stripe R
		BK172	3444131	Mouldboard stripe L
		BK173	3444140	Mouldboard stripe R
		BK173	3444141	Mouldboard stripe L
	BK140	2101002	Frog R	
	BK140	2101003	Frog L	

Shares and points		Bolt box no.	Article-no.	Designation
	3352010	BK032	3365540	EUROPOINT rev. R
	3352011	BK032	3365541	EUROPOINT rev. L
	3352020	BK036	3364050	EUROPOINT R
	3352021	BK036	3364051	EUROPOINT L
	3352030	BK036	3364150	EUROCARBIDE M5 point R
	3352031	BK036	3364151	EUROCARBIDE M5 point L
	3352034	BK036	3352010	EUROSHARE 14" R
	3352035	BK036	3352011	EUROSHARE 14" L
	3352134	BK036	3352020	EUROSHARE 16" R
	3352135	BK036	3352021	EUROSHARE 16" L
		BK036	3352030	EUROSHARE 18" R
		BK036	3352031	EUROSHARE 18" L
		BK037	3352034	EUROSHARE 20" R
		BK037	3352035	EUROSHARE 20" L
		BK037	3352134	EUROSHARE 20" R (11mm)
		BK037	3352135	EUROSHARE 20" L (11mm)
		BK036	MOL4150	M7-Adapter R
		BK036	MOL4151	M7-Adapter L
			MOL83	M7 point
			4879058	Wegde for M7 point
	BK039	MOL2034C	EUROCARBIDE share 20" R	
	BK039	MOL2035C	EUROCARBIDE share 20" L	
	BK037	3352234	EUROCARBIDE M5 20" R	
	BK037	3352235	EUROCARBIDE M5 20" L	

Landsides and share knives		Bolt box no.	Article-no.	Designation
	3411460	BK008	3401900AK10	Landside, front R
	3411500	BK008	3401901AK10	Landside, front L
	3411504	BK036	3411500	Landside, short R&L
	3411508	BK036	3411504	Landside, long R&L
		BK037	3411508	Landside, tall R&L
		BK037	3411460	Landside, tall R&L
		BK003	3492890	Share knife R
		BK003	3492891	Share knife L
			3401900AK10	
			3401901AK10	

Parts to mount on landsides		Bolt box no.	Article-no.	Designation
	63600A	BK094	63600A	Wearing plate, rev. R&L
	63601A	BK094	63601A	Wearing plate, rev. R&L
	1349408	BK052	1349408	Sword coulter R
	1349409	BK052	1349409	Sword coulter L
	800MOL	BK096	800MOL	Subsoiler blade R
	801MOL	BK096	801MOL	Subsoiler blade L

Parts to fit:

## VOGEL & NOOT ploughbody UN 400

		<b>Bolt box no.</b>	<b>Article-no.</b>	<b>Designation</b>
<b>Mouldboard and shin</b>				
<p>PK400102 PK400202</p> <p>PK400103 PK400203</p>			PK400102	Mouldboard R
			PK400202	Mouldboard L
	<i>BK021</i>		PK400103	Shin R
	<i>BK021</i>		PK400203	Shin L

<b>Shares and points</b>					
<p>PK401301 PK401401</p> <p>PK501301 PK501401</p> <p>PK801101R PK801102L</p>			<i>BK112</i>	PK401301	EUROSHARE 16" R
			<i>BK112</i>	PK401401	EUROSHARE 16" L
			<i>BK112</i>	PK501301	EUROSHARE 18" R
			<i>BK112</i>	PK501401	EUROSHARE 18" L
		<i>BK094</i>	PK801101R	EUROPOINT, rev. R	
		<i>BK094</i>	PK801102L	EUROPOINT, rev. L	

<b>Landsides</b>				
<p>P5801101</p> <p>P8903601 P8903701</p> <p>P8903401 P8903501</p>			P5801101	Wearing plate R&L
			P8903401	Landside, short R
			P8903501	Landside, short L
			P8903601	Landside, long R
		P8903701	Landside, long L	

<b>Parts to mount on landsides</b>					
<p>63600A</p> <p>63601A</p> <p>1349408 1349409</p> <p>800MOL 801MOL</p>			<i>BK094</i>	63600A	Wearing plate, rev. R&L
			<i>BK094</i>	63601A	Wearing plate, rev. R&L
			<i>BK052</i>	1349408	Sword coulter R
			<i>BK052</i>	1349409	Sword coulter L
			<i>BK096</i>	800MOL	Subsoiler blade R
			<i>BK096</i>	801MOL	Subsoiler blade L

Parts to fit:

## VOGEL & NOOT ploughs

<b>Skim shares</b>					
<p>LZ135601 LZ135701</p> <p>PA305402 PA305502</p>			<i>BK069</i>	Lz135601	Skim share R
			<i>BK069</i>	LZ135701	Skim share L
			<i>BK026</i>	PA305402	Skim mouldboard R
			<i>BK026</i>	PA305502	Skim mouldboard L

Parts to fit:

## VOGEL & NOOT ploughbody WY 400

		<b>Bolt box no.</b>	<b>Article-no.</b>	<b>Designation</b>	
<b>Mouldboard, shins and accessories</b>					
<p>PK800102 PK800202</p> <p>PK800109 PK800209</p> <p>PK805102 PK805202</p> <p>PK800501 PK800601</p>	<i>BK024</i>	PK800109	Mouldboard R		
	<i>BK024</i>	PK800209	Mouldboard L		
	<i>BK022</i>	PK800501	Shin R		
	<i>BK022</i>	PK800601	Shin L		
	<i>BK167</i>	PK805102	Turbo-trashboard R		
	<i>BK167</i>	PK805202	Turbo-trashboard L		
		PK800102	Mouldboard extension R		
		PK800202	Mouldboard extension L		
	<b>Shares and points</b>				
	<p>PK601301 PK601401</p> <p>PK701301 PK701401</p> <p>PK801101 PK801102</p>	<i>BK112</i>	PK601301	EUROSHARE 14" R	
<i>BK112</i>		PK601401	EUROSHARE 14" L		
<i>BK112</i>		PK701301	EUROSHARE 16" R		
<i>BK112</i>		PK701401	EUROSHARE 16" L		
<i>BK094</i>		PK801101R	EUROPOINT, rev. R		
<i>BK094</i>		PK801102L	EUROPOINT, rev. L		
<b>Landsides</b>					
<p>P5801101</p> <p>P8903601 P8903701</p> <p>P8903401 P8903501</p>			P8903401	Landside, short R	
		P8903501	Landside, short L		
		P8903601	Landside, long R		
		P8903701	Landside, long L		
	<b>Parts to mount on landsides</b>				
	<p>63600A</p> <p>63601A</p> <p>1349408 1349409</p> <p>800MOL 801MOL</p>	<i>BK094</i>	63600A	Wearing plate, rev. R&L	
<i>BK094</i>		63601A	Wearing plate, rev. R&L		
<i>BK052</i>		1349408	Sword coulter R		
<i>BK052</i>		1349409	Sword coulter L		
<i>BK096</i>		800MOL	Subsoiler blade R		
<i>BK096</i>		801MOL	Subsoiler blade L		



Parts to fit

# ØVERUM SR ploughbody

**Bolt box no. Article-no. Designation**

**Mouldboard, shin and accessories**

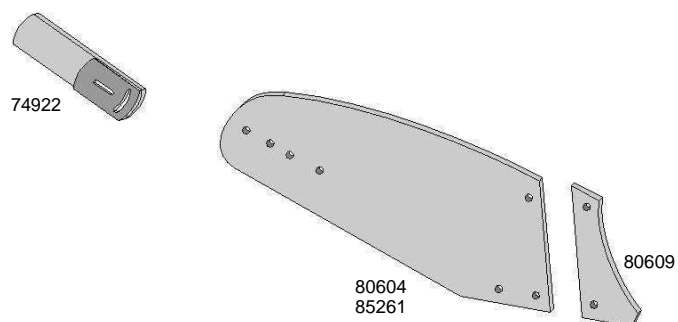

BK060	80604/85261	Mouldboard R
BK082	74922	Mouldboard extension R
BK139	80609	Shin R

**Shares and points**

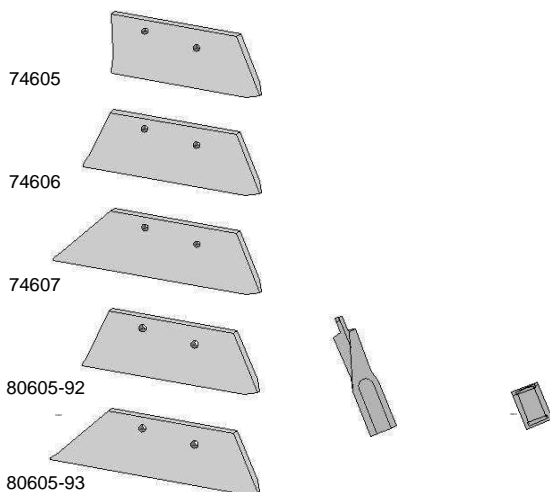

BK119	74605	EUROSHARE 12" R
BK119	74606	EUROSHARE 14" R
BK119	74607	EUROSHARE 16" R
BK050	80605-92	EUROSHARE 14" R
BK050	80605-93	EUROSHARE 16" R
	74601	Point, steel casting R
	76601	Weld-on point R

**Landsides**

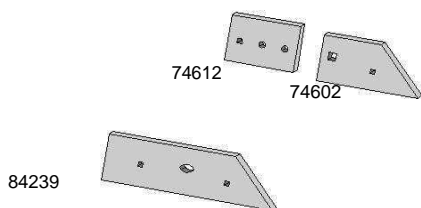

BK138	84239	Landside, short R
BK122	74612	Wearing plate, rev. R
BK130	74602	Landside, front R

**Parts to mount on landsides**

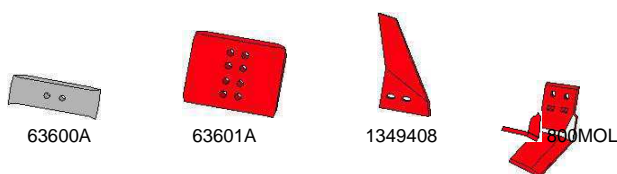

BK094	63600A	Wearing plate, rev. R&L
BK094	63601A	Wearing plate, rev. R&L
BK052	1349408	Sword coulter R
BK096	800MOL	Subsoiler blade R

Parts to fit:

## ØVERUM UC ploughbody

### Bolt box no. Articul-no. Designation

#### Mouldboard, shin and accessories

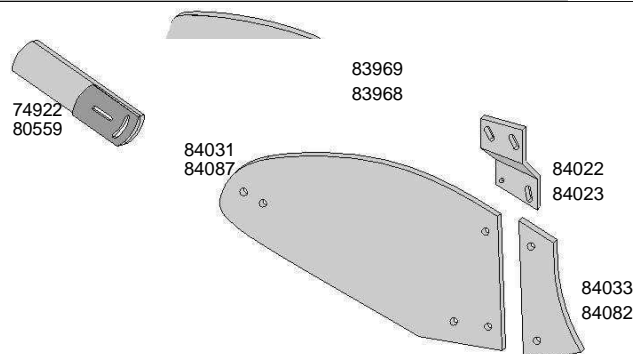

BK167	83969	Turbo-trashboard R
BK167	83968	Turbo-trashboard L
	84022	Fittings for trashboard R
	84023	Fittings for trashboard L
BK082	74922	Mouldboard extension R
BK082	80559	Mouldboard extension L
BK062	84031	Mouldboard R
BK062	84087	Mouldboard L
BK065	84033	Shin R
BK065	84082	Shin L

#### Shares and points

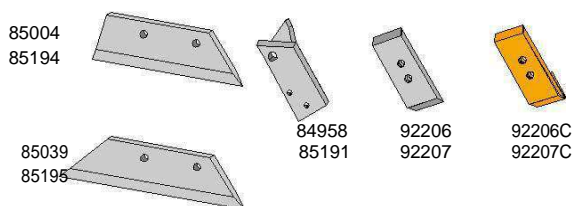

BK087	92206	EUROPOINT, rev. R
BK087	92207	EUROPOINT, rev. L
	92206C	EUROCARBIDE M3 point R
	92207C	EUROCARBIDE M3 point L
BK054	84958	Support R
BK054	85191	Support L
BK052	85004	EUROSHARE 16" R
BK052	85194	EUROSHARE 16" L
BK052	85039	EUROSHARE 18" R
BK052	85195	EUROSHARE 18" L

#### Landsides and share knives

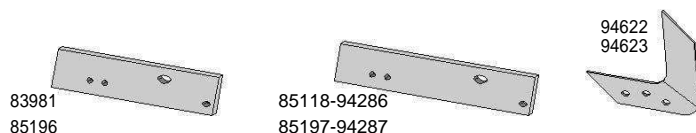

BK074	83981	Landside, short R
BK074	85196	Landside, short L
BK074	85118-94286	Landside, long R
BK074	85197-94287	Landside, long L
BK084	94622	Share knife R
BK084	94623	Share knife L

#### Parts to mount on Landsides

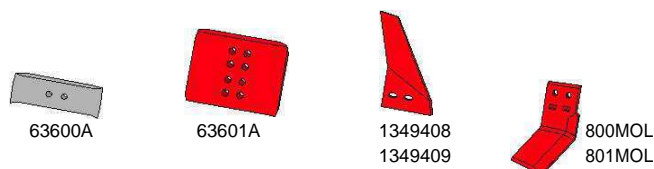

BK094	63600A	Wearing plate, rev. R&L
BK094	63601A	Wearing plate, rev. R&L
BK052	1349408	Sword coulter R
BK052	1349409	Sword coulter L
BK096	800MOL	Subsoiler blade R
BK096	801MOL	Subsoiler blade L

### Did you know...

that the carbide coating is always on the backside of Mølbros EUROCARBID points, which gives the point a self-sharpening effect, so it always attacks the ground as best as possible, even if it is almost worn.

Parts to fit:

# ØVERUM V ploughbody

## Bolt box no. Article-no. Designation

### Mouldboards, shins and accessories

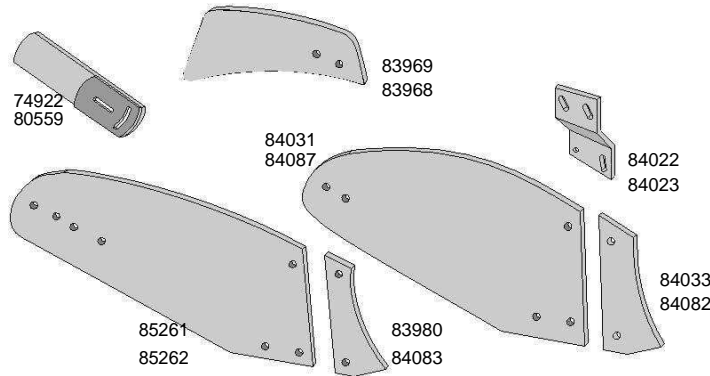

BK167	83969	Turbo-trashboard R
BK167	83968	Turbo-trashboard L
	84022	Fittings for trashboard R
	84023	Fittings for trashboard L
BK082	74922	Mouldboard extension R
BK082	80559	Mouldboard extension L
BK062	84031	Mouldboard R
BK062	84087	Mouldboard L
BK065	84033	Shin R
BK065	84082	Shin L
BK064	85261	Mouldboard R
BK064	85262	Mouldboard L
BK065	83980	Shin R
BK065	84083	Shin L

### Shares and points

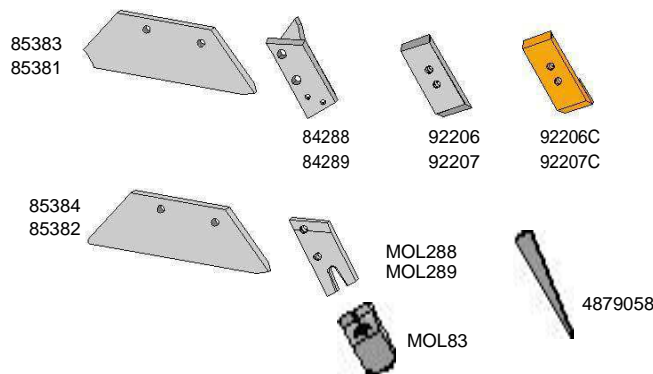

BK069	92206	EUROPOINT, rev. R
BK069	92207	EUROPOINT, rev. L
BK069	92206C	EUROCARBIDE M3 point R
BK069	92207C	EUROCARBIDE M3 point L
BK055	84288	Support R
BK055	84289	Support L
BK052	85383	EUROSHARE 16" R
BK052	85381	EUROSHARE 16" L
BK052	85384	EUROSHARE 18" R
BK052	85382	EUROSHARE 18" L
BK031	MOL288	M7-Adapter R
BK031	MOL289	M7-Adapter L
	MOL83	M7 point rev. R/L
	4879058	Wedge for M7 point

### Landsides and share knives

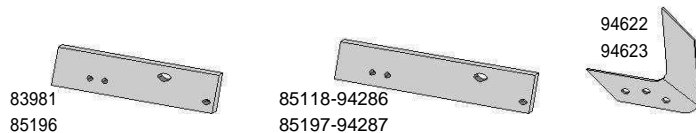

BK074	83981	Landside, short R
BK074	85196	Landside, short L
BK074	85118-94286	Landside, long R
BK074	85197-94287	Landside, long L
BK084	94622	Share knife R
BK084	94623	Share knife L

### Parts to mount on landsides

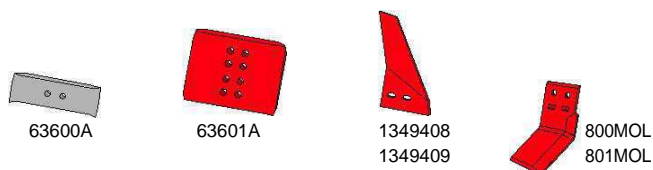

BK094	63600A	Wearing plate, rev. R&L
BK094	63601A	Wearing plate, rev. R&L
BK052	1349408	Sword coulter R
BK052	1349409	Sword coulter L
BK096	800MOL	Subsoiler blade R
BK096	801MOL	Subsoiler blade L

Parts to fit:

# ØVERUM XL ploughbody

## Bolt box no. Article-no. Designation

### Mouldboards, shins and accessories

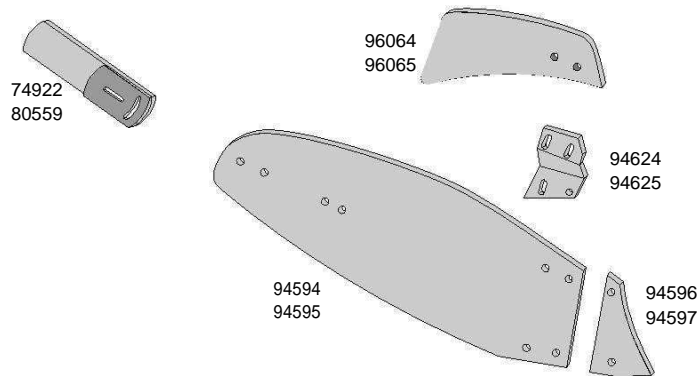

BK167	96064-83969	Turbo-trashboard R
BK167	96065-83968	Turbo-trashboard L
BK082	94624	Fittings for trashboard R
BK082	94625	Fittings for trashboard L
BK082	74922	Mouldboard extension R
BK082	80559	Mouldboard extension L
BK066	94594	Mouldboard R
BK066	94595	Mouldboard L
BK052	94596	Shin R
BK052	94597	Shin L

### Shares an points

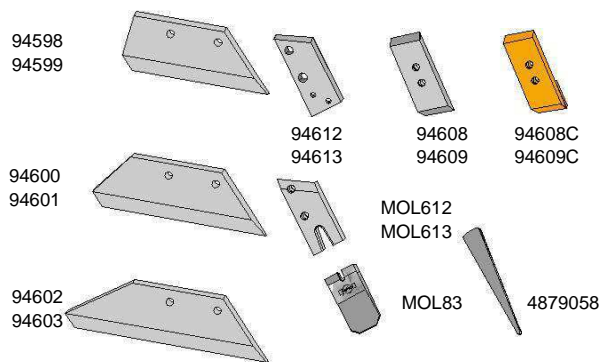

BK086	94608	EUROPOINT, rev. R
BK086	94609	EUROPOINT, rev. L
BK069	94608C	EUROCARBIDE M3 point R
BK069	94609C	EUROCARBIDE M3 point L
BK069	94612	Support R
BK069	94613	Support L
BK031	MOL612	M7-Adapter R
BK031	MOL613	M7-Adapter L
	MOL83	M7 point rev. R/L
	4879058	Wegde for M7 point
BK052	94598	EUROSHARE 14" R
BK052	94599	EUROSHARE 14" L
BK052	94600	EUROSHARE 16" R
BK052	94601	EUROSHARE 16" L
BK052	94602	EUROSHARE 18" R
BK052	94603	EUROSHARE 18" L

### Landsides and share knives

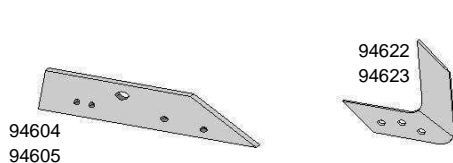

Bk074	94604	Landside R
BK074	94605	Landside L
BK084	94622	Share knife R
BK084	94623	Share knife L

### Parts to mount on landsides

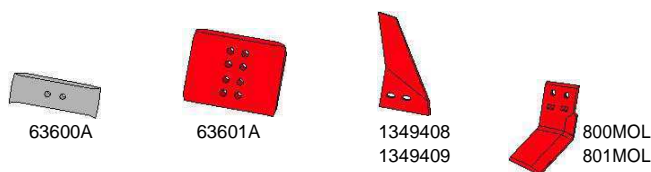

BK094	63600A	Wearing plate, rev. R&L
BK094	63601A	Wearing plate, rev. R&L
BK052	1349408	Sword coulter R
BK052	1349409	Sword coulter L
BK096	800MOL	Subsoiler blade R
BK096	801MOL	Subsoiler blade L



Parts to fit:

# ØVERUM XS ploughbody

## Bolt box no. Article-no. Designation

### Mouldboards and shins

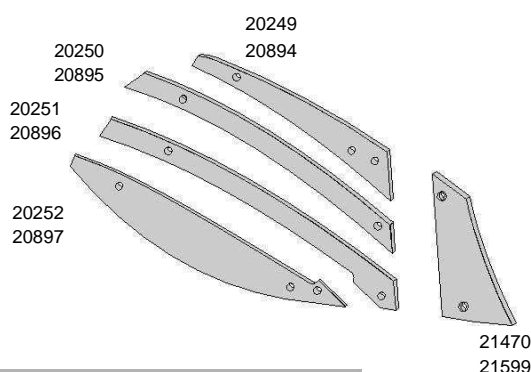

BK058	20249	Mouldboard stripe R
BK058	20894	Mouldboard stripe L
BK052	20250	Mouldboard stripe R
BK052	20895	Mouldboard stripe L
BK052	20251	Mouldboard stripe R
BK052	20896	Mouldboard stripe L
BK058	20252	Mouldboard stripe R
BK058	20897	Mouldboard stripe L
BK052	21470	Shin R
BK052	21599	Shin L

### Shares and points

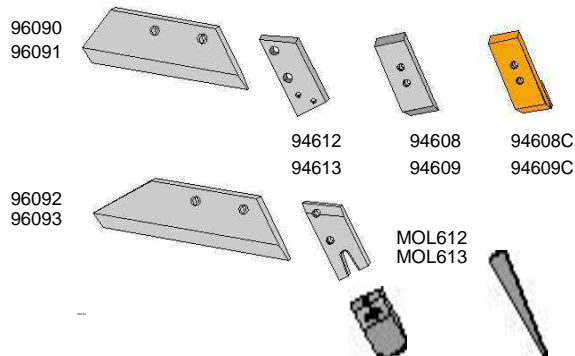

BK086	94608	EUROPOINT, rev. R
BK086	94609	EUROPOINT, rev. L
BK069	94608C	EUROCARBIDE M3 point R
BK069	94609C	EUROCARBIDE M3 point L
BK069	94612	Support R
BK069	94613	Support L
BK052	96090	EUROSHARE 16" R
BK052	96091	EUROSHARE 16" L
BK052	96092	EUROSHARE 18" R
BK052	96093	EUROSHARE 18" L
BK031	MOL612	M7-Adapter R
BK031	MOL613	M7-Adapter L
	MOL83	M7 point rev. R/L
	4879058	Wegde for M7 point

### Landsides and share knives

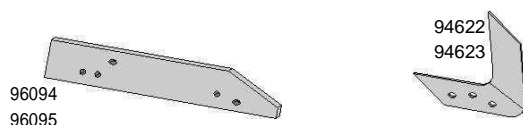

BK069	96094	Landside R
BK069	96095	Landside L
BK084	94622	Share knife R
BK084	94623	Share knife L

### Parts to mount on landsides

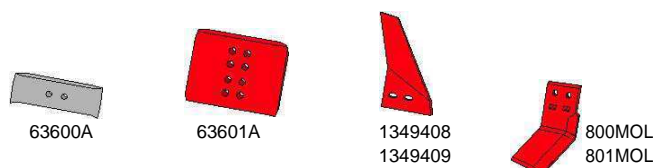

BK094	63600A	Wearing plate, rev. R&L
BK094	63601A	Wearing plate, rev. R&L
BK052	1349408	Sword coulter R
BK052	1349409	Sword coulter L
BK096	800MOL	Subsoiler blade R
BK096	801MOL	Subsoiler blade L

Parts to fit:

## ØVERUM XU ploughbody

### Bolt box no. Articiel-no. Designation

#### Mouldboard, shin and accessories

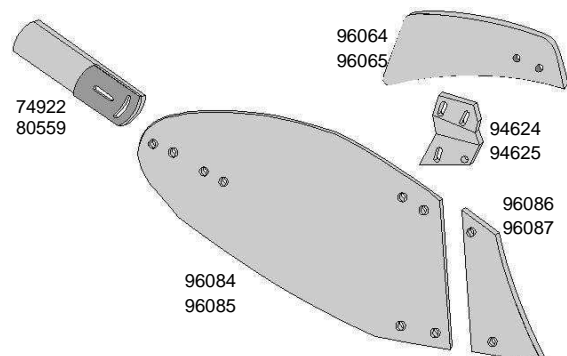

BK167	96064	Turbo-trashboard R
BK167	96065	Turbo-trashboard L
BK082	94624	Fittings for trashboard R
BK082	94625	Fittings for trashboard L
BK082	74922	Mouldboard extension R
BK082	80559	Mouldboard extension L
BK067	96084	Mouldboard R
BK067	96085	Mouldboard L
BK052	96086	Shin R
BK052	96087	Shin L

#### Shares and points

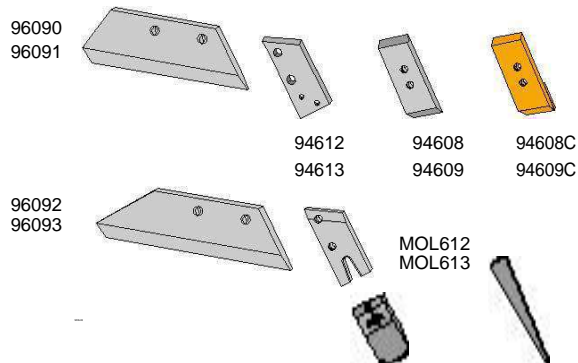

BK069	94608	EUROPOINT, rev. R
BK069	94609	EUROPOINT, rev. L
BK069	94608C	EUROCARBIDE M3 point R
BK069	94609C	EUROCARBIDE M3 point L
BK069	94612	Bracket plate R
BK069	94613	Bracket plate L
BK031	MOL612	M7-Adapter R
BK031	MOL613	M7-Adapter L
	MOL83	M7 point rev. R/L
	4879058	Wegde for M7 point
BK052	96090	EUROSHARE 16" R
BK052	96091	EUROSHARE 16" L
BK052	96092	EUROSHARE 18" R
BK052	96093	EUROSHARE 18" L

#### Landsides and share knives

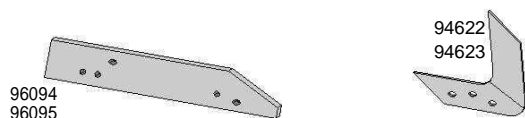

BK069	96094	Landside R
BK069	96095	Landside L
BK084	94622	Share knife R
BK084	94623	Share knife L

#### Parts to mount on landsides

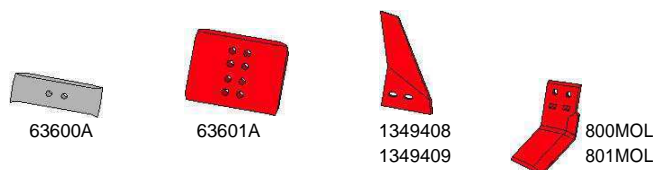

BK094	63600A	Wearing plate, rev. R&L
BK094	63601A	Wearing plate, rev. R&L
BK052	1349408	Sword coulter R
BK052	1349409	Sword coulter L
BK096	800MOL	Subsoiler blade R
BK096	801MOL	Subsoiler blade L

Parts to fit:

## ØVERUM ploughs

**Bolt box no. Article-no. Designation**

### Skim shares and skim mouldboards

 80645   80644	 91803  91804  91801  91802	<i>BK003</i>	80645	Skim mouldboard R
		<i>BK052</i>	91803	Skim mouldboard R
		<i>BK052</i>	91804	Skim mouldboard L
		<i>BK052</i>	95509	Skim mouldboard R
		<i>BK052</i>	95510	Skim mouldboard L
 81519	 95509  95510	<i>BK008</i>	81519	Skim share R
		<i>BK001</i>	86322	Skim share R
		<i>BK001</i>	86323	Skim share L
		<i>BK050</i>	80644	Skim share R
 86322  86323	 93055  93054	<i>BK052</i>	91801	Skim share R
		<i>BK052</i>	91802	Skim share L
		<i>BK052</i>	93055	Skim share R
		<i>BK052</i>	93054	Skim share L

### Disc coulters

 73249  73242A	 80966  80967AH  80967AV		73249	Cover for disc coulters R&L
			80966	Cover for disc coulters R&L
			73242A	Hub disc coulters R&L
			80967AH	Hub disc coulters M30R
			80967AV	Hub disc coulters M30L
 72547			72547	Disc coulters 18" R&L
 80662			80662	Disc coulters 20" R&L
 80663			80663	Disc coulters, rippled 20" R&L

Parts to fit:

## ØVERUM SM, SML and SMK ploughbodies

### Shares and points

 72633   71345	 72635   76601	<i>BK122</i>	72633	Share 14" R
		<i>BK122</i>	71345	Share 16" R
			76601	Weld-on point R
			72635	Point, steel casting R

Parts to fit:

## KVERNELAND Subsoiler "S" model AGROMAT

**Bolt box no. Article-no. Designation**

Wings and points

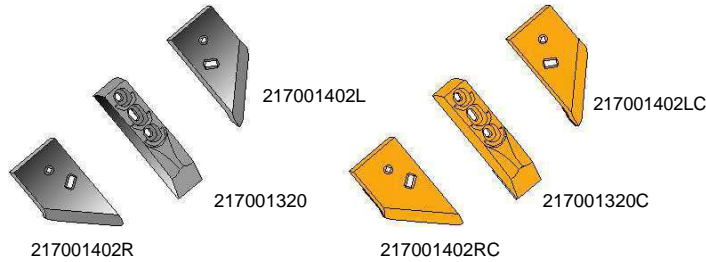

	217001320	Rev. point
	217001320C	EUROCARBIDE point
BK044	217001402R	Wing R, wide
BK044	217001402L	Wing L, wide
BK044	217001402RC	Wing R, carbide coated
BK044	217001402LC	Wing L, carbide coated

Parts to fit:

## KVERNELAND Bonator

Wings and points

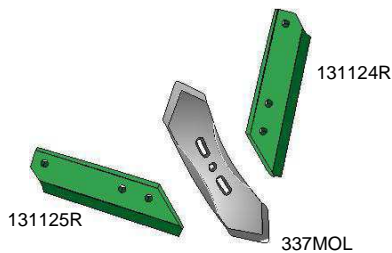

BK099	131124R	Wing R
BK099	131125R	Wing L
BK034	337MOL	Rev. point 12 x 120 x 455

Parts to fit:

## Standard Harrows and Subsoiler

Shares and points

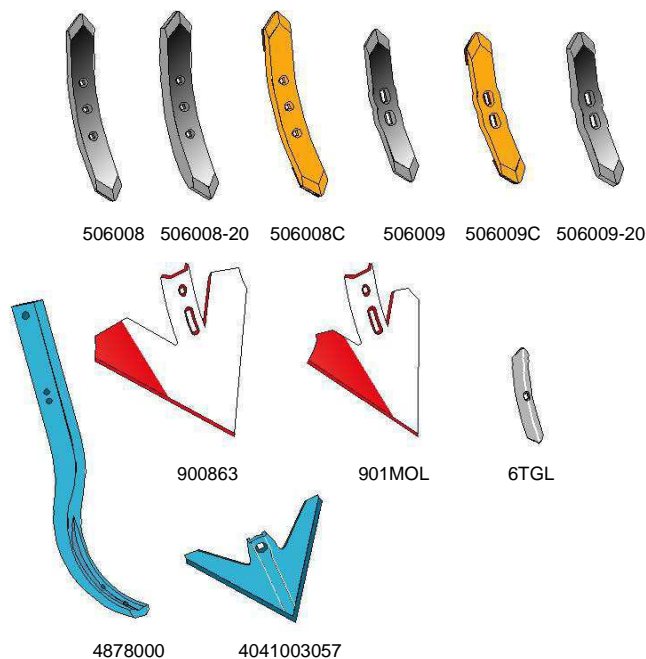













BK046	506008	Rev. point, 16 x 60 x 495
BK046	506008-20	Rev. point, 20 x 60 x 495
BK046	506008C	EUROCARBIDE point rev, 16 x 60 x 495
BK046	506009	Rev. point, 15 x 55 x 410
BK046	506009C	EUROCARBIDE point rev, 15 x 55 x 410
BK046	506009-20	Rev. point, 13 x 55 x 410
BK047	900863	Duck foot point, 460mm
BK047	901MOL	Duck foot point, 310mm
BK160	6TGL	EUROPOINT, rev. 6 x 40 x 210
	4041003057	Duck foot point, 252mm
	4878000	Universal beam

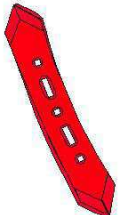

Parts to fit:

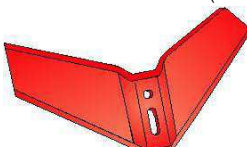
## Standard Harrows and Subsoiler

	<u>Bolt box no.</u>	<u>Article-no.</u>	<u>Designation</u>
<b>Wings and points</b>			
	<i>BK034</i>	334MOL	Rev. point, 16 x 60 x 490
	<i>BK034</i>	335MOL	Rev. point, 12 x 80 x 420
	<i>BK034</i>	336MOL	Rev. point, 12 x 100 x 420
	<i>BK034</i>	337MOL	Rev. point, 10 x 120 x 455
	<i>BK034</i>	338MOL	Rev. point, 10 x 130 x 485
	<i>BK034</i>	339MOL	Rev. point, 12 x 100 x 480
		HC121	Point turned R 80 x 12 x 510
		HC122	Point turned L 80 x 12 x 510
	<i>BK021</i>	92536 (506301)	Wing R, 8mm
	<i>BK021</i>	92537 (506302)	Wing L, 8mm
	<i>BK147</i>	500MOL	EUROWING wing 500 x 14 mm
	<i>BK147</i>	320MOL	EUROWING wing 320 x 12mm

Parts to fit:

## US Standard Subsoiler, CASE, NEW HOLLAND

	NN101582 (33310060)	Wing point, standard 330 x 190 x 30mm
	NN10685	Point, standard 330 x 30mm
	BN90989	C NELSON Duck foot point, 200mm
	C NELSON	Point 50 x 8mm

Parts to fit:

## Standard Discs for Kverneland, Horsch, Fortschritt etc.

Discs			Article-no.	Designation
			331354271	Disc, notched Ø 660x6 mm fits to:  Fortschritt
			MDU1-660	Disc, notched Ø 660x6 mm fits to:  Kuhn 117109 Väderstad 406938 (Ø42) Vogel & Noot DSQ06609 (Ø41)
			MDU3-660-6	Disc, notched Ø 660x6 mm fits to:  Dalbo 72387 (41x41) Rabe 64423202 (30x30) Kverneland KK121220R (40x40)
			MDU4-660-6	Disc Ø 660x6 mm fits to:  Dalbo 72387 (41x41) Rabe 64423202 (30x30) Kverneland KK121220R (40x40) Rau RF28474
			MDU5-660-6	Disc Ø 660x6 mm fits to:  Kuhn 117109 Väderstad 406938 (Ø42)  (Ø41)

Should you require a particular share hole in your 660 mm disc, please let us have details, and we will quote according.

Parts to fit:

## Standard Discs for Kverneland, Horsch, Fortschritt etc.

Discs			Article-no.	Designation
	<p>MDU4-610-6</p>		MDU4-610-6	Disc Ø 610x6 mm
	<p>MDU4-510-6</p>		MDU4-510-6	Disc Ø 510x6 mm <i>fits to:</i> Dalbo 72388 (41x41)

**Should you require a particular share hole in your 660 mm disc, please let us have details, and we will quote according.**

Parts to fit:

## Hub for disc coulters (Kverneland DXG etc.)

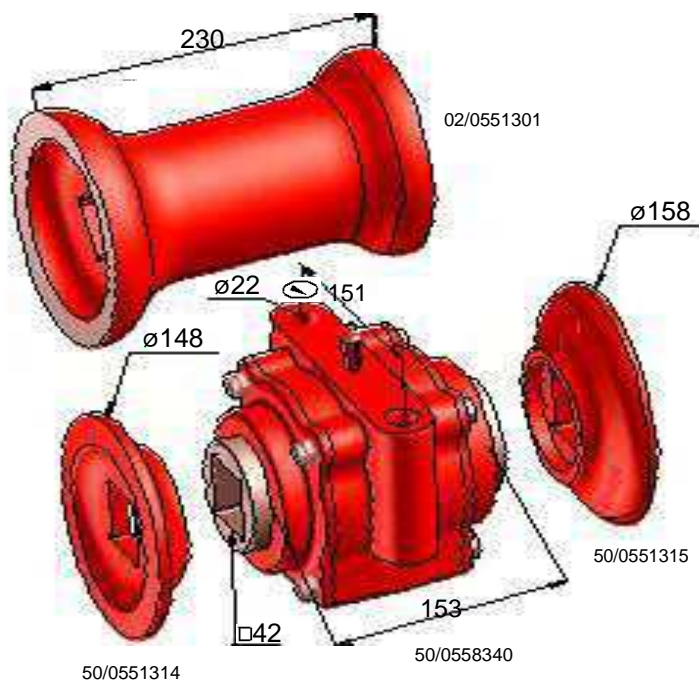

05/0558340	Steel bearing shell 42x42
50/0551315	Convex flange 42x42
50/0551314	Convex flange 42x42

Parts to fit:

## LEMKEN Smaragd / Topas Harrows

Wings, points and accessories				Bolt box no.	Article-no.	Designation
				BK048	4679105	Foot - Stein 10
3374398	3374395	4679105	3374399	BK049	3374398	Guide board outer R
				BK049	3374395	Guide board center
	3374416	3374388	3374417	BK049	3374399	Guide board outer L
				BK088	3374416	Wing 10 mm R
	3374418	3374388-12	3374419	BK088	3374417	Wing 10 mm L
	3374420		3374421	BK088	3374418	Wing, Curved 10 mm R
				BK088	3374419	Wing, Curved 10 mm L
				BK088	3374420	Wing, Curved 11 mm R
				BK088	3374421	Wing, Curved 11 mm L
				BK088	3374424C-15	Wing, Curved, carbide R
3374424C-12	3374424C-15	3374392C	3374425C-15	BK088	3374425C-15	Wing, Curved, carbide L
				BK088	3374424C-12	Wing, Curved, carbide R
				BK088	3374425C-12	Wing, Curved, carbide L
				BK035	3374388	EUROPOINT 120x10
				BK035	3374388-12	EUROPOINT 120x12
				BK035	3374392C	EUROCARBIDE point 120x12
				BK035	3374392-15C	EUROCARBIDE point 120x15

Parts to fit:

## LEMKEN Thorit / Achat Harrows

Wings, points and accessories				Bolt box no.	Article-no.	Designation
				BK049	3374398	Guide board outer R
3374398	3374395	4679105	3374399	BK049	3374395	Guide board center
				BK048	4679105	Guide board center
3374388	3374388-12	3374392C	3374392-15C	BK049	3374399	Guide board outer L
				BK035	3374388	EUROPOINT 120x10
3374428C	3374428	3374429	3374429C	BK035	3374388-12	EUROPOINT 120x12
				BK035	3374392C	EUROCARBIDE point 120x12
				BK035	3374392-15C	EUROCARBIDE point 120x15
				BK088	3374428C	Wing, Curved, carbide R
3374401	4679107	3374386	3374386C	BK088	3374428	Wing, Curved, R
				BK088	3374429	Wing, Curved, L
				BK088	3374429C	Wing, Curved, carbide L
				BK049	3374401	Guide board center
				BK048	4679107	Foot
				BK035	3374386	EUROPOINT 80x12
				BK035	3374386C	EUROCARBIDE point 80x12



Parts to fit:

## LEMKEN Harrows

Points and disc coulters

**Bolt box no. Article-no. Designation**

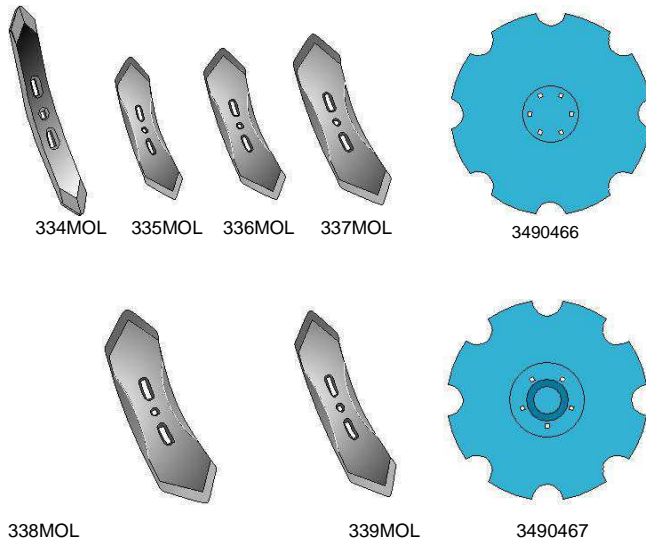

BK034	334MOL	Rev. Point 16 x 60 x 490
BK034	335MOL	Rev. point, 12 x 80 x 420
BK034	336MOL	Rev. Point, 12 x 100 x 420
BK034	337MOL	Rev. point, 10 x 120 x 455
BK034	338MOL	Rev. point, 10 x 130 x 485
BK034	339MOL	Rev. point, 12 x 100 x 480
	3490466	Disc coulters, concave, notched Ø625mm
	3490467	Disc coulters, concave, notched Ø625mm

Parts to fit:

## LEMKEN-KOMPAKTOR Harrows

Point



BK017	3374356	Duck foot point 250 x 5
-------	---------	----------------------------

Parts to fit:

## LEMKEN-Drill machines



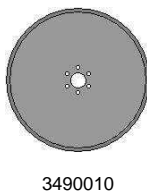

Seeding

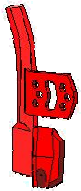
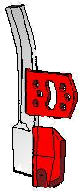
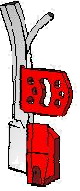
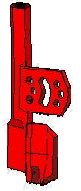
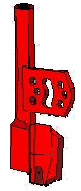
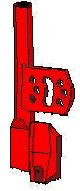
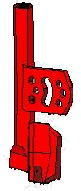
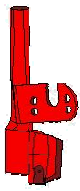
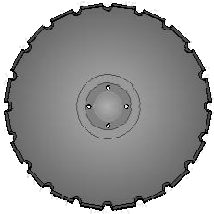
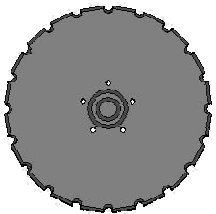
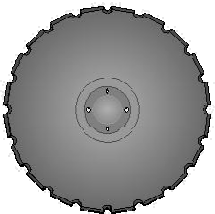
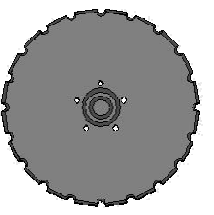
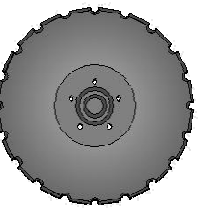
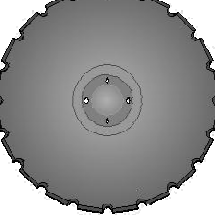
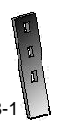
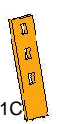

	3490010	Seeding Disc, flat Ø350mm
--	---------	------------------------------

Parts to fit:

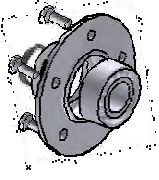
## VÄDERSTAD Drill machines

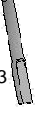



















	<b>Bolt box no.</b>	<b>Article-no.</b>	<b>Designation</b>
<b>Fertilizing</b>			
		432120	Seed share, fertilizer R
		432121	Seed share, fertilizer L
		432120MOL-SF	Seed share, fertilizer R Stainless steel
		432121MOL-SF	Seed share, fertilizer L Stainless steel
		432120MOL-SLF	Combo seed share, liquid fertilizer R, Stainless steel
		432121MOL-SLF	Combo seed share, liquid fertilizer R, Stainless steel
<b>Seeding</b>			
		432117	Seed share R
		432116	Seed share L
		432117-3	Seed share R 3mm
		432116-3	Seed share L 3mm
		499059	Bean share
		499060	Bean share
		432119	Seed share R, short slit
		432118	Seed share L, short slit
		307108	Seed share R
		307107	Seed share L
		444687/423787	Disc coulter, concave, notched Ø432mm
		451793	Disc coulter, notched Ø370mm
		459608	Disc coulter, concave, notched Ø432mm
		451371	Disc coulter, notched Ø410mm
		451372	Disc coulter, concave, notched Ø410mm
		466947	Disc coulter, concave, notched Ø450mm
		BK088 419998-1	Wearing plate 45x10
		BK088 419998-1C	Wearing plate 45x10
		BK088 419999-1	Wearing plate 80x8
		420832	Hub for disc coulter
		BK023 302300	Rev. point
		BK160 6TGL	Rev. point 6 x 40 x 210
		400703	Harrow point round Ø28 x 300

Parts to fit:

## VÄDERSTAD Harrows

Wings, points and accessories

**Bolt box no. Article-no. Designation**

			<i>BK148</i> 452956	Guide board R	
			<i>BK148</i> 461309	Guide board L	
			<i>BK148</i> 452957	Guide board center	
452956	461309	452957			
				457618C	
				<i>BK048</i> 457618	
				<i>BK048</i> 452854	
				<i>BK048</i> 452854C	
457618	452854	452854	457618C		
				447151	
				155027	
				155028	
				447150	
				447151	
155027	155028	447150	447151		
					
					<i>BK034</i> 334MOL
					<i>BK034</i> 335MOL
					<i>BK034</i> 336MOL
					<i>BK034</i> 337MOL
					<i>BK034</i> 338MOL
					<i>BK034</i> 339MOL
334MOL	335MOL	336MOL	337MOL	338MOL	339MOL
					
					<i>BK044</i> 201388-1
					<i>BK044</i> 201387-1
					<i>BK046</i> 355652
					<i>BK046</i> 355652C
					447152
201388-1	201387-1	355652	355652C	447152	

**Did you know that...**

Mølbros universal MOL-subsoiler serie fits to almost all cultivators, harrows and models in Europe?

## EUROCARBIDE Wearing parts ploughs

Parts to fit..

### AGROLUX

EUROPOINTS coated

**Bolt box no. Article no. Designation**



84987C  
85206C

BK031	84987C	EUROCARBIDE M5 point R
BK031	85206C	EUROCARBIDE M5 point L

Parts to fit..

### FORTSCHRITT, FRAUGE

EUROPOINTS coated



9310MOLC



5309MOLC

BK095	9310MOLC	EUROCARBIDE M3 point R
BK095	5309MOLC	EUROCARBIDE M3 point R

Parts to fit..

### GREGORIE-BESSON

EUROPOINTS coated



MOL332C  
MOL331C

BK095	MOL332C	EUROCARBIDE M3 point R
BK095	MOL331C	EUROCARBIDE M3 point L

Parts to fit..

### KUHN

Accessories coated



MOL180C  
MOL181C

BK095	MOL180C	EUROCARBIDE M3 point R
BK095	MOL181C	EUROCARBIDE M3 point L

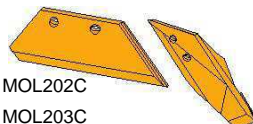

MOL202C  
MOL203C

MOL200C  
MOL201C

BK166	MOL200C	EUROCARBIDE M5 point R
BK166	MOL201C	EUROCARBIDE M5 point L

BK165	MOL202C	EUROCARBIDE M5 share 16" R
BK165	MOL203C	EUROCARBIDE M5 share 16" L

## Did you know...

Mølbros uses a special developed and specified powder wire, which is getting weld on with six-axis welding robots to ensure maximum precision?



## EUROCARBIDE Wearing parts ploughs

Parts to fit.

### KVERNELAND ploughbodies no. 6,7,8,9, 28

EUROPOINT M5 coated

**Bolt box no. Article no. Designation**

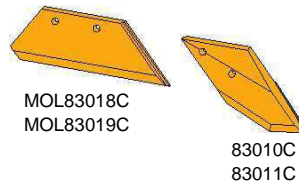

BK144	83010C	EUROCARBIDE M5 point R
BK144	83011C	EUROCARBIDE M5 point L
BK111	MOL83018C	EUROCARBIDE M5 16" R
BK111	MOL83019C	EUROCARBIDE M5 16" L

EUROCARBIDE, EUROPOINTS coated

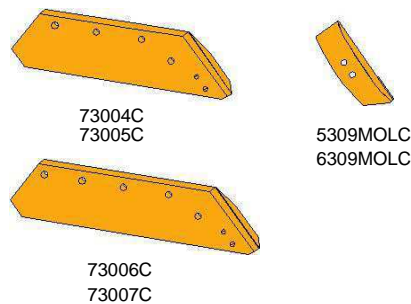

BK113	073004C	EUROCARBIDE share 16" R
BK113	073005C	EUROCARBIDE share 16" L
BK114	073006C	EUROCARBIDE share 18" R
BK114	073007C	EUROCARBIDE share 18" L
BK095	5309MOLC	EUROCARBIDE M3 point R
BK095	6309MOLC	EUROCARBIDE M3 point L

Landsides coated

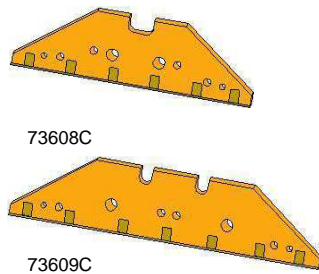

BK111	73608C	EUROCARBIDE,landside,short R&L
BK111	73609C	EUROCARBIDE,landside,long R&L

Parts to fit.

### KVERNELAND ploughbodies no. 12,19 & 20,30

EUROSHARE M5 coated

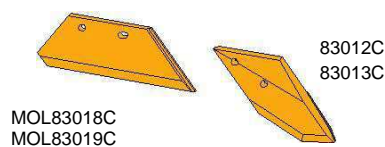

BK170	MOL83018C	EUROCARBID M5 share 16" R
BK170	MOL83019C	EUROCARBID M5 share 16" L
BK144	83012C	EUROCARBID M5 point R
BK144	83013C	EUROCARBID M5 point L

## EUROCARBIDE Wearing parts ploughs

Parts to fit..  
**LEMKEN**

Accessories coated

**Bolt box no. Article no. Designation**

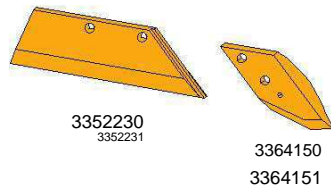

BK031 3352230 EUROCARBIDE M5 18" R  
BK031 3352231 EUROCARBIDE M5 18" L

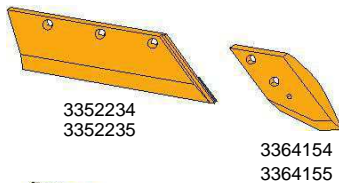

BK036 3364150 EUROCARBIDE M5 point R  
BK036 3364151 EUROCARBIDE M5 point L  
BK036 3364154 EUROCARBIDE M5 point R  
BK036 3364155 EUROCARBIDE M5 point L

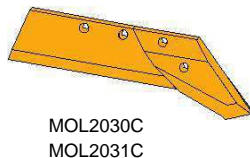

BK037 3352234 EUROCARBIDE M5 20" R  
BK037 3352235 EUROCARBIDE M5 20" L

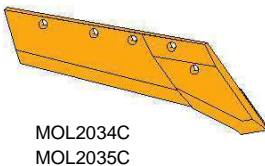

BK038 MOL2030C EUROCARBIDE share 18" R  
BK038 MOL2031C EUROCARBIDE share 18" L

BK039 MOL2034C EUROCARBIDE share 20" R  
BK039 MOL2035C EUROCARBIDE share 20" L

### ***Did you know...***

*Mølbros is using a matrix of different carbides, such as tungsten or niobium in different sizes?*

### ***Did you know...***

*The coating process resulting in matrix material which have cohesively connection with the base material - this ensures optimal durability of the coating?*

## EUROCARBIDE Wearing parts ploughs

Parts to fit..

### MASSEY-FERGUSON

Accessories coated

**Bolt box no. Article no. Designation**



84987C  
85206C

<i>BK031</i>	84987C	EUROCARBIDE M5 point R
<i>BK031</i>	85206C	EUROCARBIDE M5 point L

Parts to fit..

### RABE

Accessories coated

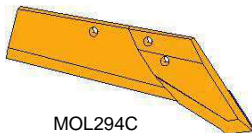

MOL294C  
MOL294CL

<i>BK037</i>	MOL294C	EUROCARBIDE share 18" R
<i>BK037</i>	MOL294CL	EUROCARBIDE share 18" L

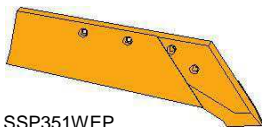

SSP351WEP  
SSP351WEPL



MOL350C  
MOL350LC

<i>BK095</i>	MOL350C	EUROCARBIDE M3 point R
<i>BK095</i>	MOL350CL	EUROCARBIDE M3 point L
<i>BK038</i>	SSP351WEP	EUROCARBIDE share R
<i>BK038</i>	SSP351WEPL	EUROCARBIDE share L

Parts to fit..

### ØVERUM

Accessories coated



92206C  
92207C



84060C  
85143C



94608C  
94609C

<i>BK069</i>	92206C	EUROCARBIDE M3 point R
<i>BK069</i>	92207C	EUROCARBIDE M3 point L
<i>BK069</i>	84060C	EUROCARBIDE M3 point R
<i>BK069</i>	85143C	EUROCARBIDE M3 point L
<i>BK069</i>	94608C	EUROCARBIDE M3 point R
<i>BK069</i>	94609C	EUROCARBIDE M3 point L

## EUROCARBIDE Wearing parts, and subsoilers

Parts to fit..  
**HORSCH**

Wings and Points coated

**Bolt box no. Article no. Designation**

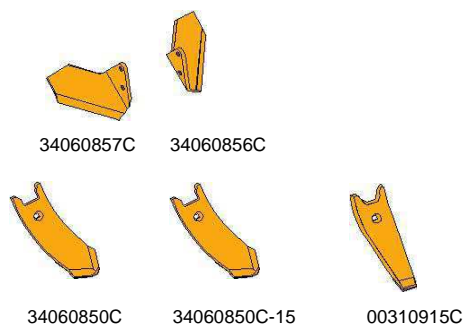

34060857C Wing, coated R  
34060856C Wing, coated L

BK148 34060850C EUROCARBIDE point  
85 x 12  
BK148 34060850C-15 EUROCARBIDE point 15mm  
85 x 15  
BK148 00130915C EUROCARBIDE point 15mm  
85 x 15  
BK014 342MOL EUROCARBIDE point

Parts to fit..

**KERNER**

Points coated



BK162 92281C EUROCARBIDE point  
12 x 120 x 240

Parts to fit..

**KVERNELAND**

Wings and Points coated

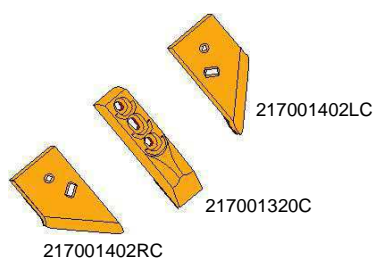

217001320C EUROCARBIDE point

BK044 217001402C Wing R  
BK044 217001402LC Wing L

Parts to fit..

**KÖCKERLING**

Points coated

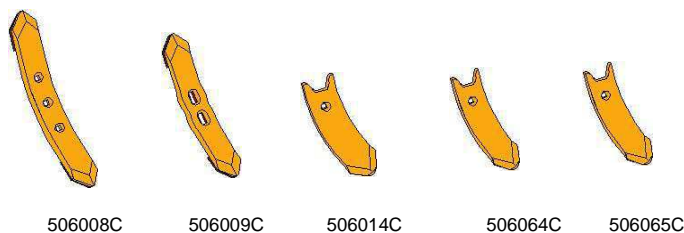

BK046 506008C EUROCARBIDE point, rev,  
16 x 60 x 495  
BK046 506009C EUROCARBIDE point, rev,  
15 x 55 x 410  
BK148 506014C EUROCARBIDE point,  
12 x 100 x 288.  
BK148 506064C EUROCARBIDE point,  
12 x 80 x 288.  
BK148 506065C EUROCARBIDE point,



## EUROCARBIDE Wearing parts subsoiler

Parts to fit..

**Bolt box no. Article no. Designation**

### LEMKEN

Wings and Points coated

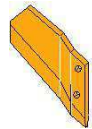

3374424C-12

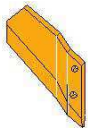

3374424C



3374392C

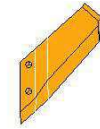

3374425C

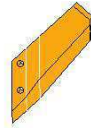

3374425C-12



3374392-15C



3374386C

BK088	3374424C	Wing Curved, coated R
BK088	3374425C	Wing Curved, coated L
	3374424C-12	Wing Curved, coated R
	3374425C-12	Wing Curved, coated L
BK035	3374392C	EUROCARBIDE point 12mm
BK035	3374392-15C	EUROCARBIDE point 15mm
BK035	3374386C	EUROCARBIDE point

Parts to fit..

### Standard

Points coated



506008C



506009C



355652C

BK046	506008C	EUROCARBIDE point, rev, 16 x 60 x 495
BK046	506009C	EUROCARBIDE point, rev, 15 x 55 x 410
BK046	355652C	EUROCARBIDE point, rev, 19 x 57 x 460

Parts to fit..

### Väderstad

Points coated



452854C



419998-1C

BK048	452854C	EUROCARBID spids, 80 x 12
BK088	419998-1C	Wearing plate 45x10

## Disc coulters and accessories

Parts to fit:

### KVERNELAND

Disc coulters and accessories

Article-no. Designation



56156



60609

56156  
60609

Universal cover for hub  
Hub disc coulters  $\text{Æ}34\text{mm}$

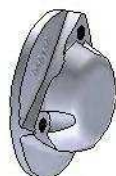

56156



60624

56156  
60624

Universal cover for hub  
Hub disc coulters  $\text{Æ}30\text{mm}$



56156

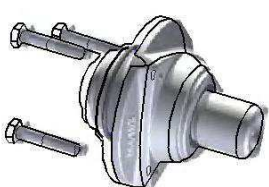

60609CA

56156  
60609CA

Universal cover for hub  
Hub disc coulters  $\text{Æ}30\text{mm}$



86100



86087R

### **Did you know...**

*that all bearings produced by Mølbro are electrostatic galvanized?*

## Disc coulters and accessories

---

Parts to fit:

**VÄDERSTAD**

Disc coulters and accessories

Article-no. Designation



420832

Parts to fit:

**ÖVERUM**

Disc coulters and accessories



73249

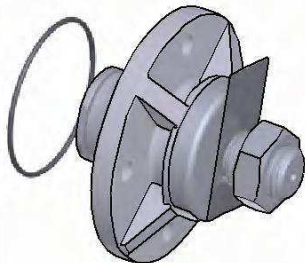

73242A

73249  
73242A

Cover for hub  
Hub for disc coulters  
1 1/8" WGL

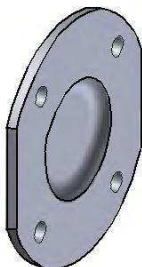

80966 80967AH 80967AV

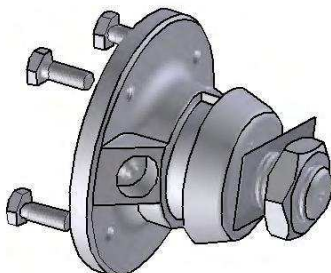

80966  
80967AH  
80967AV

Cover for hub  
Hub for disc coulters M30R  
Hub for disc coulters M30L







SUMINISTROS INDUSTRIALES

WENCES

Calle Alfonso Senra, 171 - bajo  
15680 Ordes  
(A Coruña)

+34 981 682 385

+34 699 980 621